

## General Description

The silicon carbide power MOSFET utilizes Oriental-Semi's advanced technology to achieve low on-resistance, low gate charge, low Qrr and excellent thermal performance by exploiting innovative properties of wide bandgap materials. It is engineered to minimize conduction loss and provide superior switching performance almost independent of temperature.

The silicon carbide power MOSFET provides high reliability and extremely high efficiency. It is targeted to improve application performance in frequency, energy efficiency, reliability, system size and weight reduction.

## Features

- High blocking voltage with low on-resistance
- High-speed switching with low capacitances
- IGBT-compatible driving voltage (15V for turn-on)
- Fast intrinsic diode with low reverse recovery (Qrr)
- Temperature independent turn-off switching losses
- Halogen free, RoHS compliant
- AEC-Q101 Qualified



## Applications

- Solar inverters
- On-board charger/PFC
- EV motor drive
- High voltage DC/DC converters
- Switch mode power supplies

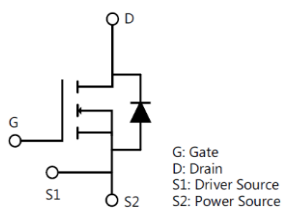
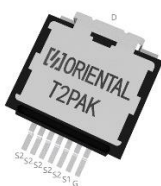
## Key Performance Parameters

Parameter	Value	Unit
$V_{DS}$	1200	V
$I_D$ , pulse	92	A
$R_{DS(ON)}$ , typ @ $V_{GS}=18V$	60	m $\Omega$
$Q_g$	48	nC

## Marking Information

Product Name	Package	Marking
OSQ120R060K9T2AF	T2PAK	OSQ120R060K9T2A

## Package & Pin Information



**Absolute Maximum Ratings** at  $T_j=25^{\circ}\text{C}$  unless otherwise noted

Parameter	Symbol	Value	Unit
Drain-source voltage	$V_{DS}$	1200	V
Gate-source voltage (max static)	$V_{GS}$	-8/+22	V
Gate-source voltage (recommended operating values)	$V_{GS}$	-4/+18	V
Continuous drain current <sup>1)</sup> , $T_C=25^{\circ}\text{C}$	$I_D$	36	A
Continuous drain current <sup>1)</sup> , $T_C=100^{\circ}\text{C}$		25	
Pulsed drain current <sup>2)</sup>	$I_{D, pulse}$	92	A
Power dissipation <sup>3)</sup> , $T_C=25^{\circ}\text{C}$	$P_D$	150	W
Operation and storage temperature	$T_{stg}, T_j$	-55 to 175	$^{\circ}\text{C}$

**Thermal Characteristics**

Parameter	Symbol	Min.	Typ.	Max.	Unit
Thermal resistance, junction-case	$R_{\theta JC}$		0.83	1.0	$^{\circ}\text{C/W}$
Thermal resistance, junction-ambient	$R_{\theta JA}$			62	$^{\circ}\text{C/W}$

**Electrical Characteristics** at  $T_j=25^{\circ}\text{C}$  unless otherwise specified

Parameter	Symbol	Min.	Typ.	Max.	Unit	Test condition
Drain-source breakdown voltage	$BV_{DSS}$	1200			V	$V_{GS}=0\text{ V}, I_D=100\ \mu\text{A}$
Gate threshold voltage	$V_{GS(th)}$	2.3	2.8	3.6	V	$V_{DS}=V_{GS}, I_D=5\text{ mA}$
Drain-source on-state resistance	$R_{DS(ON)}$		60	75	m $\Omega$	$V_{GS}=18\text{ V}, I_D=20\text{ A}$
			110			$V_{GS}=18\text{ V}, I_D=20\text{ A}, T_j=175^{\circ}\text{C}$
			74	100	m $\Omega$	$V_{GS}=15\text{ V}, I_D=20\text{ A}$
			117			$V_{GS}=15\text{ V}, I_D=20\text{ A}, T_j=175^{\circ}\text{C}$
Transconductance	$g_{fs}$		16		S	$V_{DS} = 20\text{ V}, I_D = 20\text{ A}$
Gate-source leakage current	$I_{GSS}$			$\pm 100$	nA	$V_{GS}=-8\sim 22\text{ V}$
Drain-source leakage current	$I_{DSS}$			100	$\mu\text{A}$	$V_{DS}=1200\text{ V}, V_{GS}=0\text{ V}$
				500	$\mu\text{A}$	$V_{DS}=1200\text{ V}, V_{GS}=0\text{ V}, T_j=175^{\circ}\text{C}$
Gate resistance	$R_G$		2.3		$\Omega$	$f=1\text{ MHz}, \text{Open drain}, V_{AC}=25\text{ mV}$

### Dynamic Characteristics

Parameter	Symbol	Min.	Typ.	Max.	Unit	Test condition
Input capacitance	$C_{iss}$		1149		pF	$V_{GS}=0\text{ V}$ , $V_{DS}=800\text{ V}$ , $f=1\text{ MHz}$ , $V_{AC}=25\text{ mV}$
Output capacitance	$C_{oss}$		55		pF	
Reverse transfer capacitance	$C_{rss}$		2		pF	
$C_{oss}$ stored energy	$E_{oss}$		23		$\mu\text{J}$	
Turn-on delay time	$t_{d(on)}$		11.4		ns	$V_{GS}=-4/18\text{ V}$ , $V_{DS}=800\text{ V}$ , $R_G=5\ \Omega$ , $I_D=20\text{ A}$ , $L=120\ \mu\text{H}$ , $T_j=25\text{ }^\circ\text{C}$
Rise time	$t_r$		9.4		ns	
Turn-off delay time	$t_{d(off)}$		17.7		ns	
Fall time	$t_f$		7.8		ns	
Turn-on switching energy	$E_{on}$		137		$\mu\text{J}$	
Turn-off switching energy	$E_{off}$		31		$\mu\text{J}$	
Turn-on switching energy	$E_{on}$		129		$\mu\text{J}$	$V_{GS}=-4/18\text{ V}$ , $V_{DS}=800\text{ V}$ , $R_G=5\ \Omega$ , $I_D=20\text{ A}$ , $L=120\ \mu\text{H}$ , $T_j=175\text{ }^\circ\text{C}$
Turn-off switching energy	$E_{off}$		32		$\mu\text{J}$	

### Gate Charge Characteristics

Parameter	Symbol	Min.	Typ.	Max.	Unit	Test condition
Total gate charge	$Q_g$		48		nC	$V_{GS}=-4/18\text{ V}$ , $V_{DS}=800\text{ V}$ , $I_D=20\text{ A}$
Gate-source charge	$Q_{gs}$		16.5		nC	
Gate-drain charge	$Q_{gd}$		11		nC	

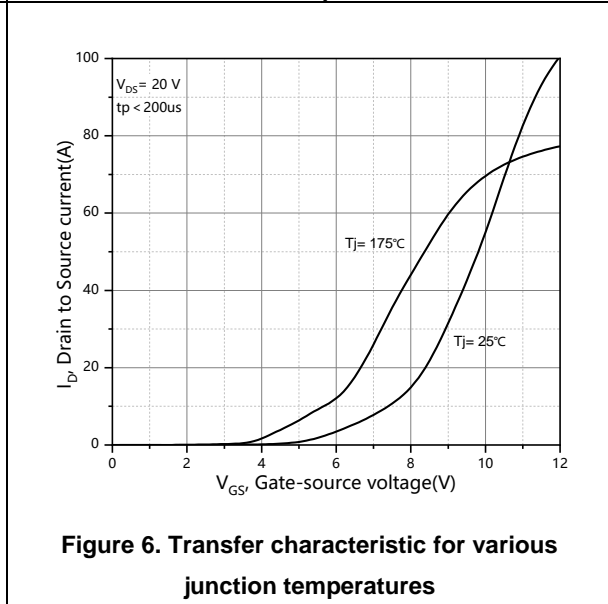
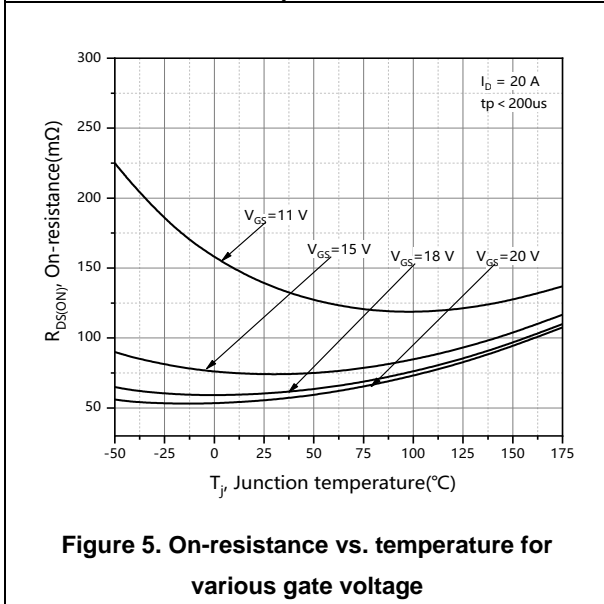
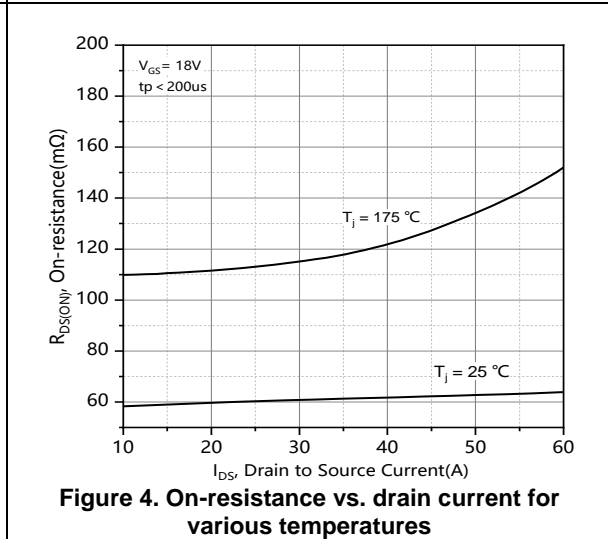
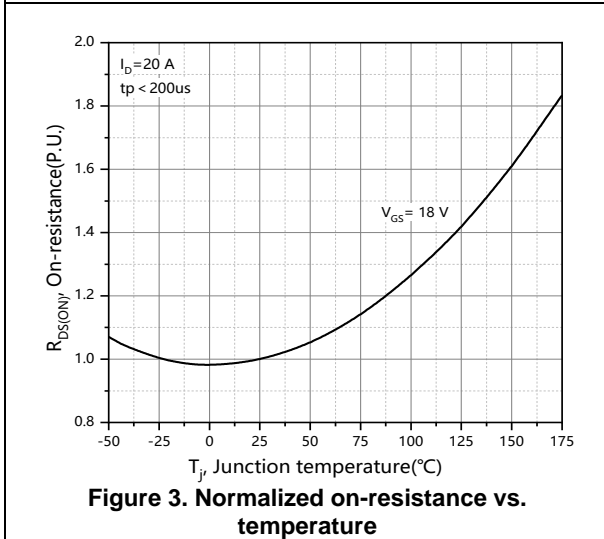
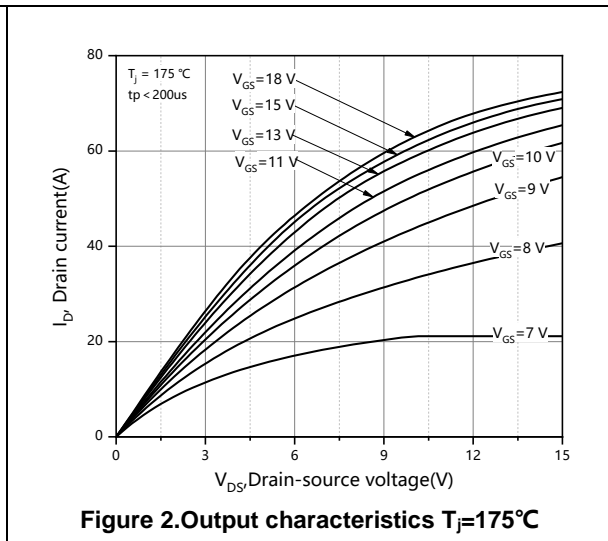
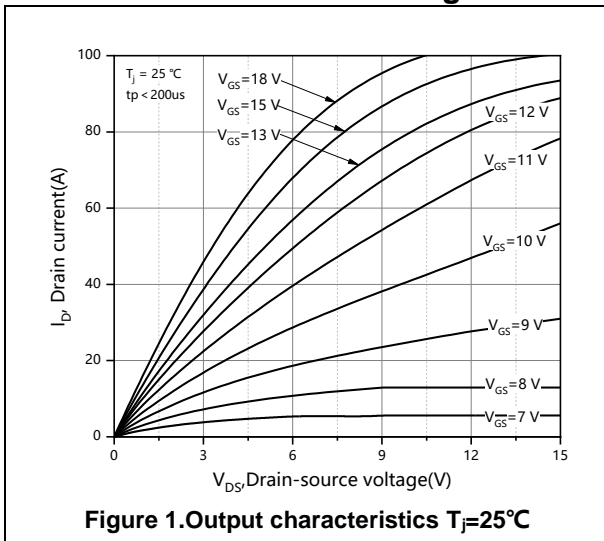
**Body Diode Characteristics**

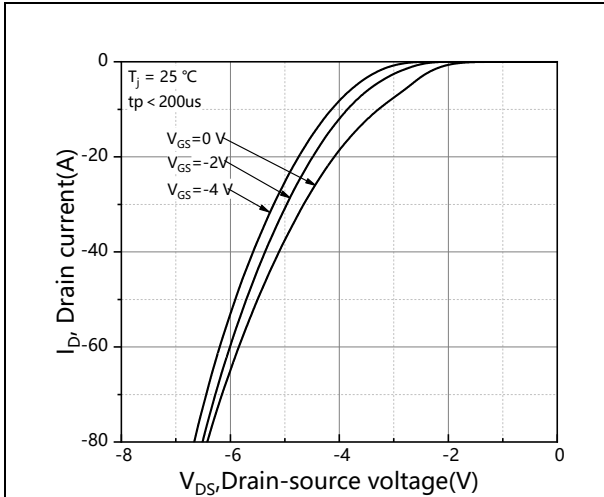
Parameter	Symbol	Min.	Typ.	Max.	Unit	Test condition
Diode forward voltage	$V_{SD}$		4.5		V	$I_S=15\text{ A}$ , $V_{GS}=-4\text{ V}$ , $T_J=25\text{ °C}$
			4.0		V	$I_S=15\text{ A}$ , $V_{GS}=-4\text{ V}$ , $T_J=175\text{ °C}$
Continuous diode forward current	$I_S$		36		A	$V_{GS}=-4\text{ V}$ , $T_J=25\text{ °C}$
Reverse recovery time	$t_{rr}$		11		ns	$V_{GS}=-4\text{ V}$ , $V_R=800\text{ V}$ ,
Reverse recovery charge	$Q_{rr}$		89		nC	$I_S=20\text{ A}$ , $di/dt=3000\text{ A}/\mu\text{s}$ , $T_J=25\text{ °C}$
Peak reverse recovery current	$I_{rrm}$		14.4		A	$T_J=25\text{ °C}$
Reverse recovery time	$t_{rr}$		71		ns	$V_{GS}=-4\text{ V}$ , $V_R=800\text{ V}$ ,
Reverse recovery charge	$Q_{rr}$		340		nC	$I_S=20\text{ A}$ , $di/dt=1000\text{ A}/\mu\text{s}$ ,
Peak reverse recovery current	$I_{rrm}$		9.2		A	$T_J=175\text{ °C}$

**Note**

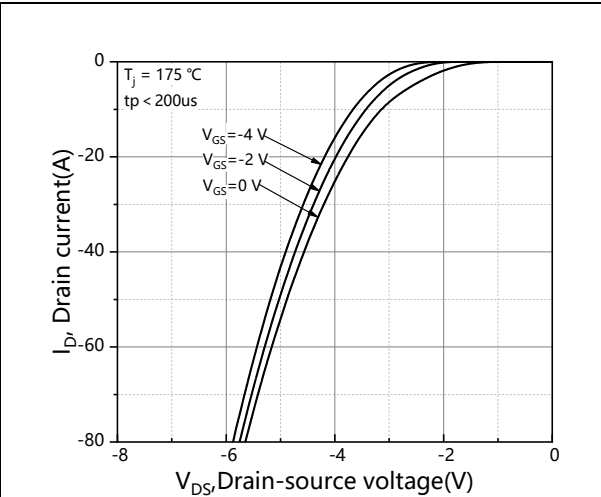
- 1) Calculated continuous current based on maximum allowable junction temperature.
- 2) Repetitive rating; pulse width limited by max. junction temperature.
- 3)  $P_d$  is based on max. junction temperature, using junction-case thermal resistance.

**Electrical Characteristics Diagrams**

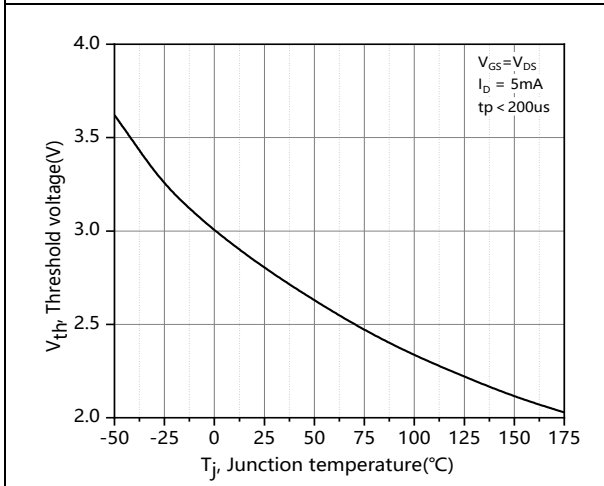




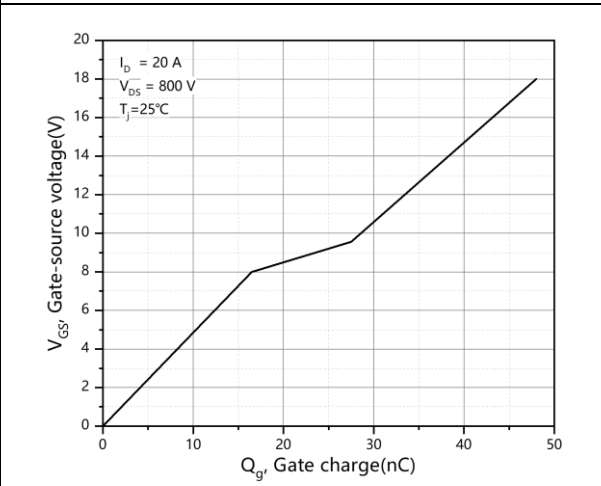
**Figure 7. Body diode characteristic at  $T_j = 25\text{ }^\circ\text{C}$**



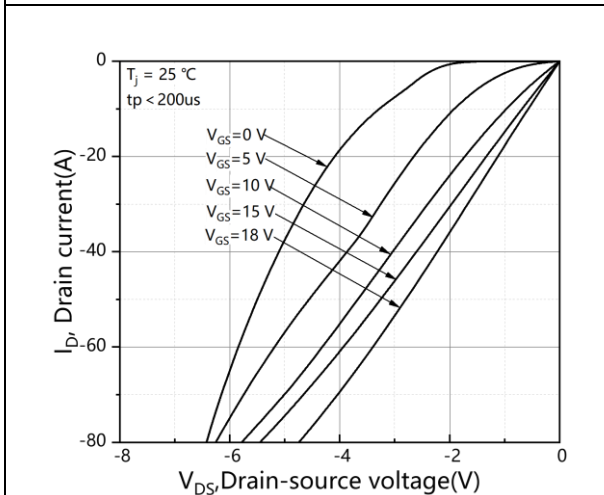
**Figure 8. Body diode characteristic at  $T_j = 175\text{ }^\circ\text{C}$**



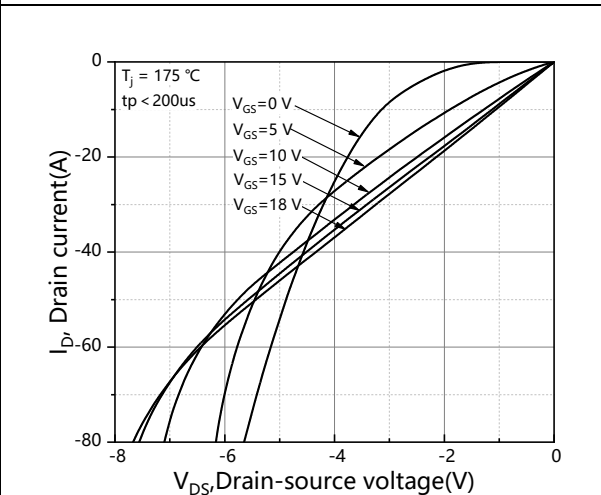
**Figure 9. Threshold voltage vs. temperature**



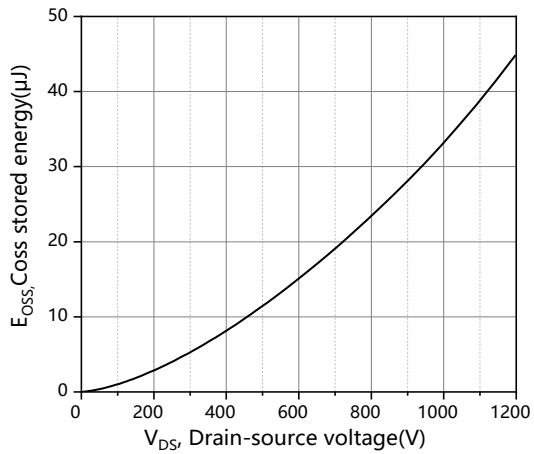
**Figure 10. Gate charge characteristic**



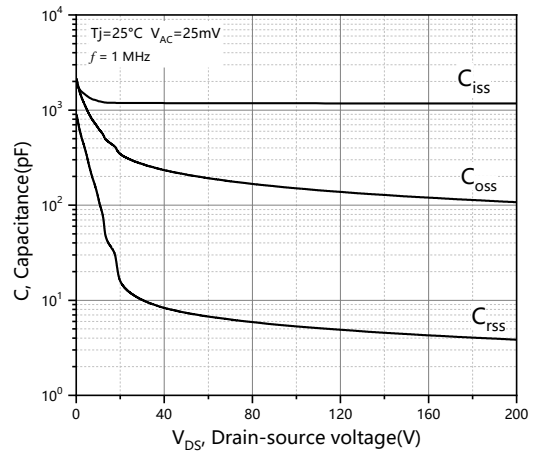
**Figure 11. 3rd quadrant characteristic at  $T_j = 25\text{ }^\circ\text{C}$**



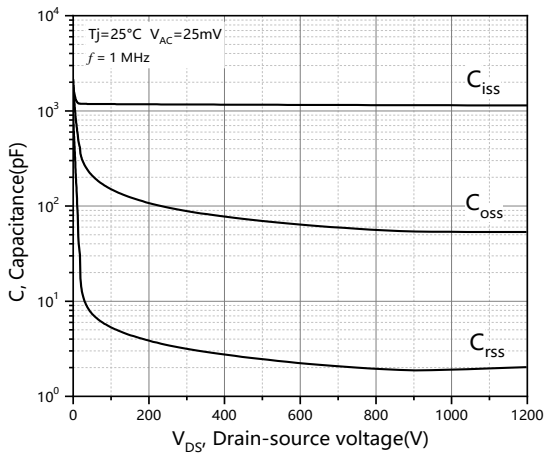
**Figure 12. 3rd quadrant characteristic at  $T_j = 175\text{ }^\circ\text{C}$**



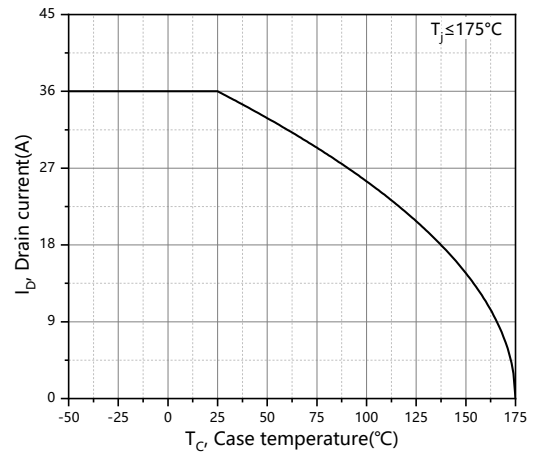
**Figure 13. Output capacitor stored energy**



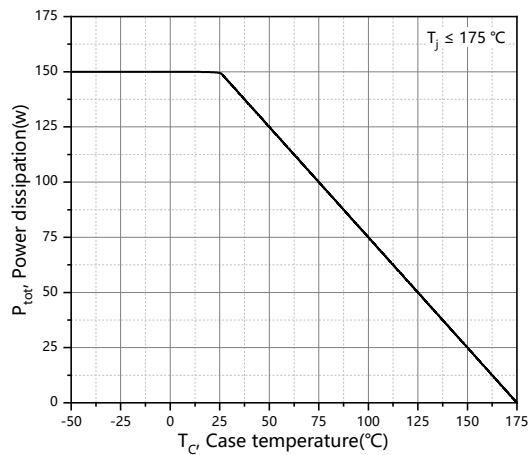
**Figure 14. Capacitances vs. drain-source voltage (0 - 200V)**



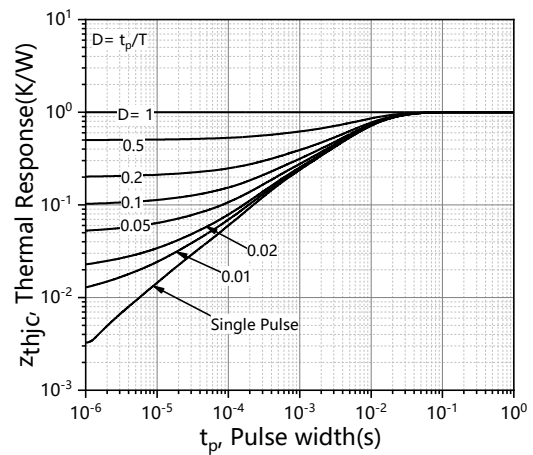
**Figure 15. Capacitances vs. drain-source voltage (0 - 1200V)**



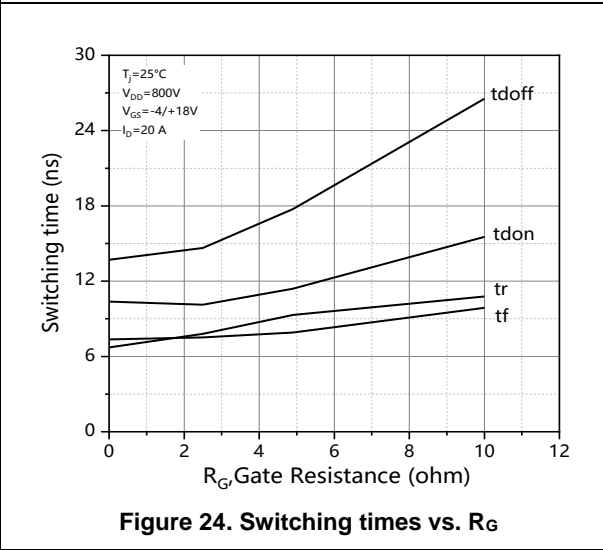
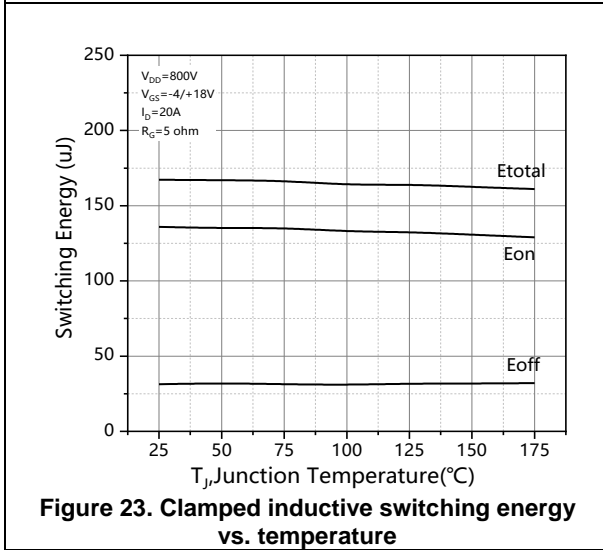
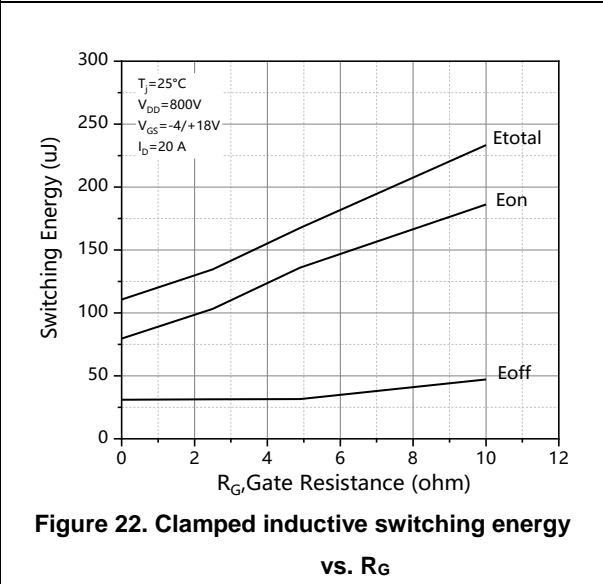
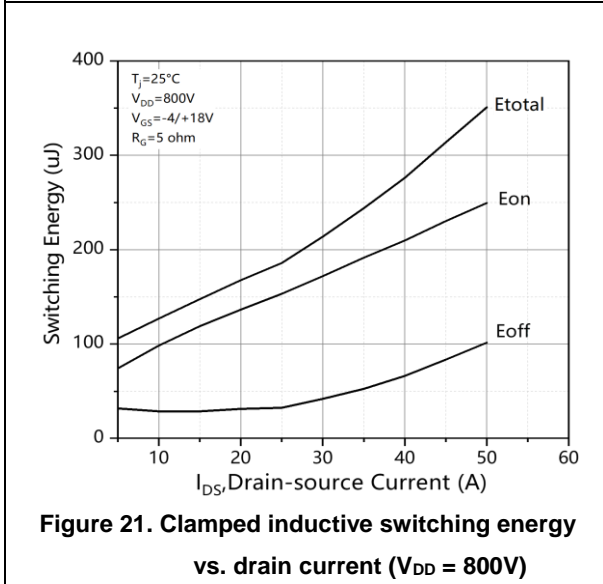
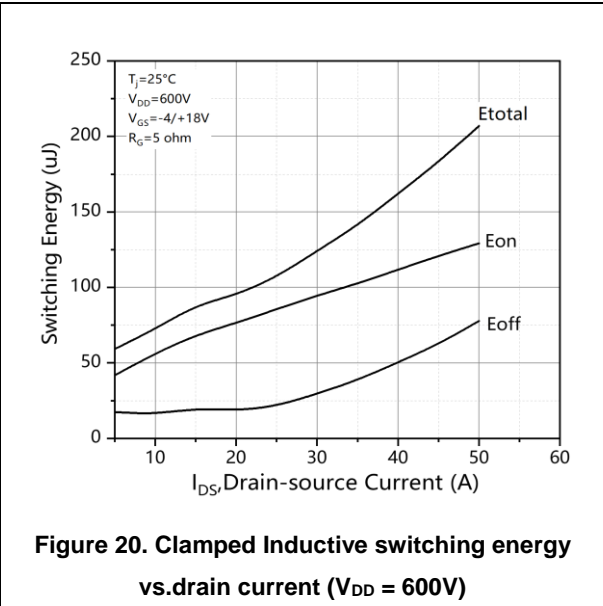
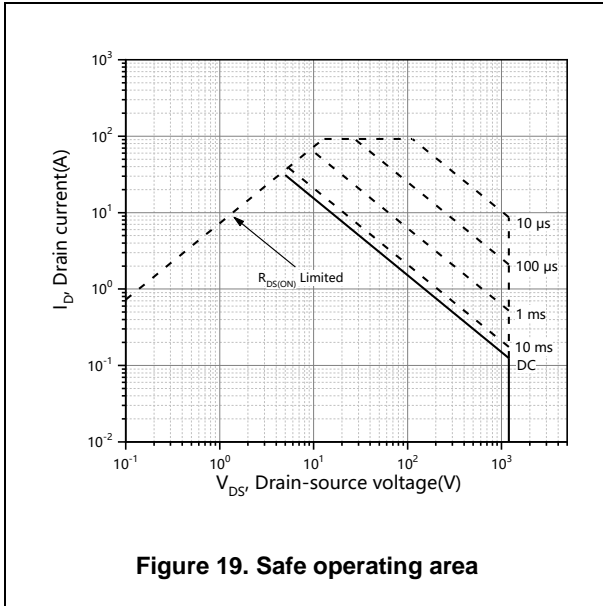
**Figure 16. Continuous drain current derating vs. case temperature**



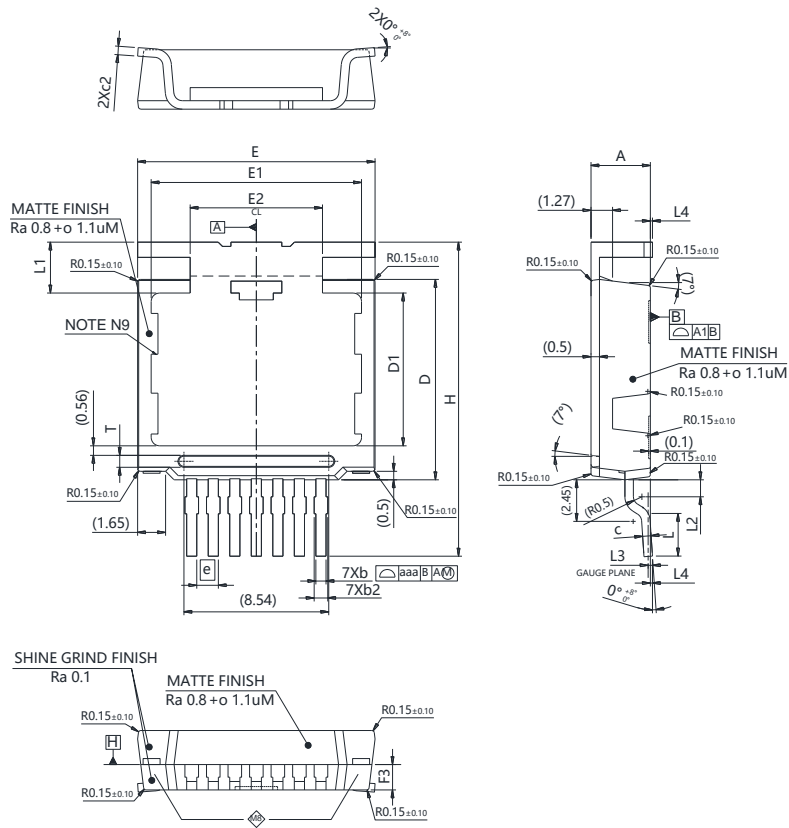
**Figure 17. Maximum power dissipation derating vs. case temperature**



**Figure 18. Transient thermal impedance (junction - case)**



**Package Information**



Symbol	mm		Symbol	mm	
	Min	Max		Min	Max
A	3.40	3.60	e	BSC1.27	
A1	0.05		H	18.00	19.00
b	0.50	0.70	L	2.40	2.60
b2	0.50	1.00	L1	3.00	3.20
b3	0.80	1.00	L2	0.90	1.10
c	0.40	0.60	L3	BSC0.26	
c2	0.40	0.60	L4	0.07	0.18
D	11.70	11.90	aaa	0.10	
D1	8.90	9.10	F3	1.40	1.60
E	13.90	14.10	N1	3.80	4.00
E1	12.30	12.50	N2	0.25	0.35
E2	7.75	7.85	N3	0.80	1.00
T	0.60	0.70	b1	0.50	0.65
c1	0.4	0.55	b4	0.50	0.95

Version : T2PAK-S -package outline dimension

### Ordering Information

Package Type	Units/ Reel	Reels/ Inner Box	Units/ Inner Box	Inner Boxes/ Carton Box	Units/ Carton Box
T2PAK-S	800	1	800	4	3200

### Product Information

Product	Package	Pb Free	RoHS	Halogen Free
OSQ120R060K9T2AF	T2PAK	yes	yes	yes

### Legal Disclaimer

The information given in this document shall in no event be regarded as a guarantee of conditions or characteristics. With respect to any examples or hints given herein, any typical values stated herein and/or any information regarding the application of the device, Oriental Semiconductor hereby disclaims any and all warranties and liabilities of any kind, including without limitation, warranties of non-infringement of intellectual property rights of any third party.

For further information on technology, delivery terms and conditions and prices, please contact the Oriental Semiconductor sales representatives ([www.orientalsemi.com](http://www.orientalsemi.com)).

© Oriental Semiconductor Co.,Ltd. All Rights Reserved /

## Revision History

Version	Revision History	Date
V0.1	Preliminary release	2025-08-13
V1.0	Initial release	2025-09-26