

General Description

The silicon carbide power MOSFET utilizes Oriental-Semi's advanced technology to achieve low on-resistance, low gate charge, low Qrr and excellent thermal performance by exploiting innovative properties of wide bandgap materials. It is engineered to minimize conduction loss and provide superior switching performance almost independent of temperature.

The silicon carbide power MOSFET provides high reliability and extremely high efficiency. It is targeted to improve application performance in frequency, energy efficiency, reliability, system size and weight reduction.

Features

- High blocking voltage with low on-resistance
- High-speed switching with low capacitances
- IGBT-compatible driving voltage (15V for turn-on)
- Fast intrinsic diode with low reverse recovery (Qrr)
- Temperature independent turn-off switching losses
- Halogen free, RoHS compliant



Applications

- Solar inverters
- On-board charger/PFC
- EV motor drive
- High voltage DC/DC converters
- Switch mode power supplies
- AEC-Q101 Qualified

Key Performance Parameters

Parameter	Value	Unit
V_{DS}	1200	V
I_D , pulse	157	A
$R_{DS(ON)}$, typ @ $V_{GS}=18V$	35	m Ω
Q_g	90	nC

Marking Information

Product Name	Package	Marking
OSQ120R035K9T2AF	T2PAK	OSQ120R035K9T2A

Pin Information

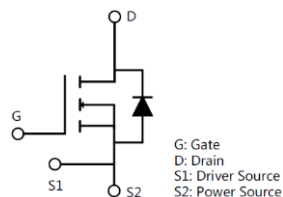
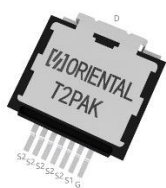

Absolute Maximum Ratings at $T_j=25^{\circ}\text{C}$ unless otherwise noted

Parameter	Symbol	Value	Unit
Drain-source voltage	V_{DS}	1200	V
Gate-source voltage (max static)	V_{GS}	-8/+22	V
Gate-source voltage (recommended operating values)	V_{GS}	-4/+18	V
Continuous drain current ¹⁾ , $T_C=25^{\circ}\text{C}$	I_D	55	A
Continuous drain current ¹⁾ , $T_C=100^{\circ}\text{C}$		39	
Pulsed drain current ²⁾	$I_{D, pulse}$	157	A
Power dissipation ³⁾ , $T_C=25^{\circ}\text{C}$	P_D	245	W
Operation and storage temperature	T_{stg}, T_j	-55 to 175	$^{\circ}\text{C}$

Thermal Characteristics

Parameter	Symbol	Min.	Typ.	Max.	Unit
Thermal resistance, junction-case	$R_{\theta JC}$		0.47	0.61	$^{\circ}\text{C/W}$
Thermal resistance, junction-ambient	$R_{\theta JA}$			62	$^{\circ}\text{C/W}$

Electrical Characteristics at $T_j=25^{\circ}\text{C}$ unless otherwise specified

Parameter	Symbol	Min.	Typ.	Max.	Unit	Test condition
Drain-source breakdown voltage	BV_{DSS}	1200			V	$V_{GS}=0\text{ V}, I_D=100\ \mu\text{A}$
Gate threshold voltage	$V_{GS(th)}$	2.3	2.8	3.6	V	$V_{DS}=V_{GS}, I_D=10\ \text{mA}$
Drain-source on-state resistance	$R_{DS(ON)}$		35	45	m Ω	$V_{GS}=18\ \text{V}, I_D=32\ \text{A}$
			62			$V_{GS}=18\ \text{V}, I_D=32\ \text{A}, T_j=175^{\circ}\text{C}$
			42	56	m Ω	$V_{GS}=15\ \text{V}, I_D=32\ \text{A}$
			65			$V_{GS}=15\ \text{V}, I_D=32\ \text{A}, T_j=175^{\circ}\text{C}$
Transconductance	g_{fs}		19		S	$V_{DS} = 20\ \text{V}, I_D = 32\ \text{A}$
Gate-source leakage current	I_{GSS}			± 100	nA	$V_{GS}=-8\sim 22\ \text{V}$
Drain-source leakage current	I_{DSS}			100	μA	$V_{DS}=1200\ \text{V}, V_{GS}=0\ \text{V}$
				500	μA	$V_{DS}=1200\ \text{V}, V_{GS}=0\ \text{V}, T_j=175^{\circ}\text{C}$
Gate resistance	R_G		1.8		Ω	$f=1\ \text{MHz}, \text{Open drain}, V_{AC}=25\ \text{mV}$

Dynamic Characteristics

Parameter	Symbol	Min.	Typ.	Max.	Unit	Test condition
Input capacitance	C_{iss}		2473		pF	$V_{GS}=0\text{ V}$, $V_{DS}=800\text{ V}$, $f=100\text{ kHz}$, $V_{AC}=25\text{ mV}$
Output capacitance	C_{oss}		96		pF	
Reverse transfer capacitance	C_{rss}		5.2		pF	
C_{oss} stored energy	E_{oss}		39		μJ	
Turn-on delay time	$t_{d(on)}$		16.3		ns	$V_{GS}=-4/18\text{ V}$, $V_{DS}=800\text{ V}$, $R_G=5\ \Omega$, $I_D=32\text{ A}$, $L=120\ \mu\text{H}$, $T_j=25\text{ }^\circ\text{C}$
Rise time	t_r		13.3		ns	
Turn-off delay time	$t_{d(off)}$		28		ns	
Fall time	t_f		8.7		ns	
Turn-on switching energy	E_{on}		260		μJ	
Turn-off switching energy	E_{off}		70		μJ	
Turn-on switching energy	E_{on}		242		μJ	$V_{GS}=-4/18\text{ V}$, $V_{DS}=800\text{ V}$, $R_G=5\ \Omega$, $I_D=32\text{ A}$, $L=120\ \mu\text{H}$, $T_j=175\text{ }^\circ\text{C}$
Turn-off switching energy	E_{off}		81		μJ	

Gate Charge Characteristics

Parameter	Symbol	Min.	Typ.	Max.	Unit	Test condition
Total gate charge	Q_g		90		nC	$V_{GS}=-4/18\text{ V}$, $V_{DS}=800\text{ V}$, $I_D=32\text{ A}$
Gate-source charge	Q_{gs}		30		nC	
Gate-drain charge	Q_{gd}		18		nC	

Body Diode Characteristics

Parameter	Symbol	Min.	Typ.	Max.	Unit	Test condition
Diode forward voltage	V_{SD}		4.1		V	$I_S=24\text{ A}$, $V_{GS}=-4\text{ V}$, $T_J=25\text{ °C}$
			3.6		V	$I_S=24\text{ A}$, $V_{GS}=-4\text{ V}$, $T_J=175\text{ °C}$
Continuous diode forward current	I_S		55		A	$V_{GS}=-5\text{ V}$, $T_J=25\text{ °C}$
Reverse recovery time	t_{rr}		13.3		ns	$V_{GS}=-4\text{ V}$, $V_R=800\text{ V}$,
Reverse recovery charge	Q_{rr}		146		nC	$I_S=32\text{ A}$, $di/dt=3000\text{ A}/\mu\text{s}$, $T_J=25\text{ °C}$
Peak reverse recovery current	I_{rrm}		19.3		A	$T_J=25\text{ °C}$
Reverse recovery time	t_{rr}		77		ns	$V_{GS}=-4\text{ V}$, $V_R=800\text{ V}$,
Reverse recovery charge	Q_{rr}		500		nC	$I_S=32\text{ A}$, $di/dt=1000\text{ A}/\mu\text{s}$,
Peak reverse recovery current	I_{rrm}		12.2		A	$T_J=175\text{ °C}$

Note

- 1) Calculated continuous current based on maximum allowable junction temperature.
- 2) Repetitive rating; pulse width limited by max. junction temperature.
- 3) P_d is based on max. junction temperature, using junction-case thermal resistance.

Electrical Characteristics Diagrams

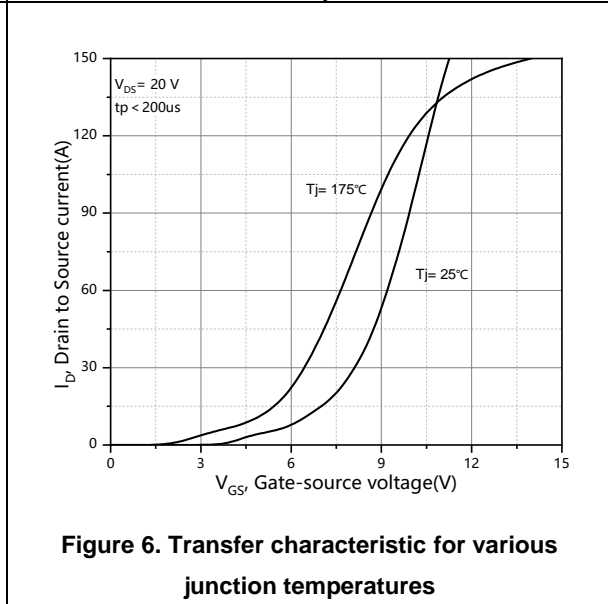
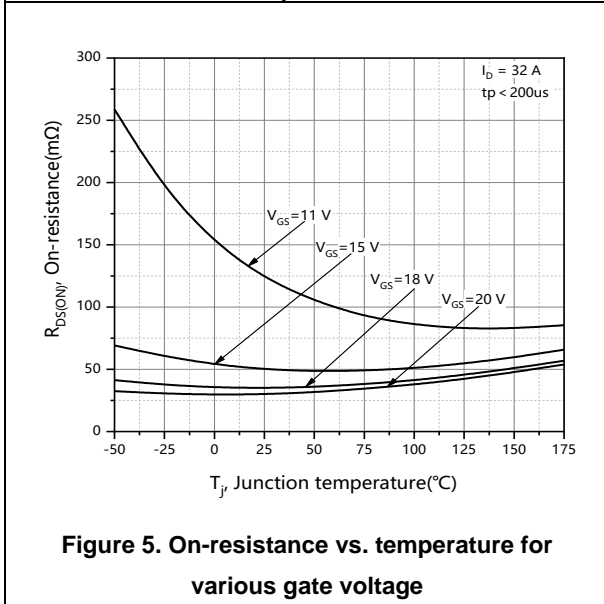
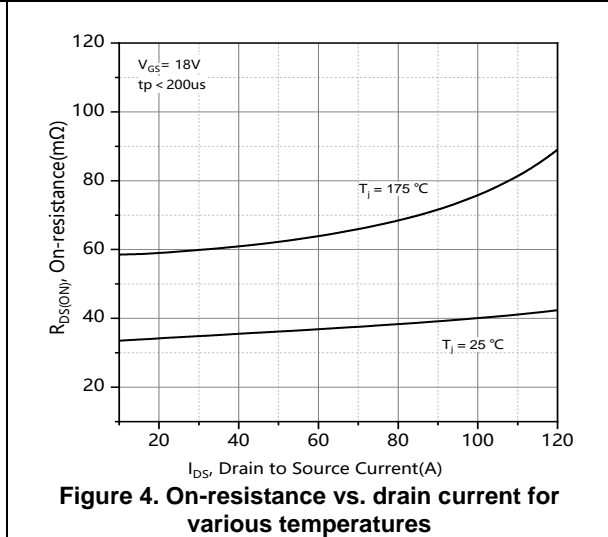
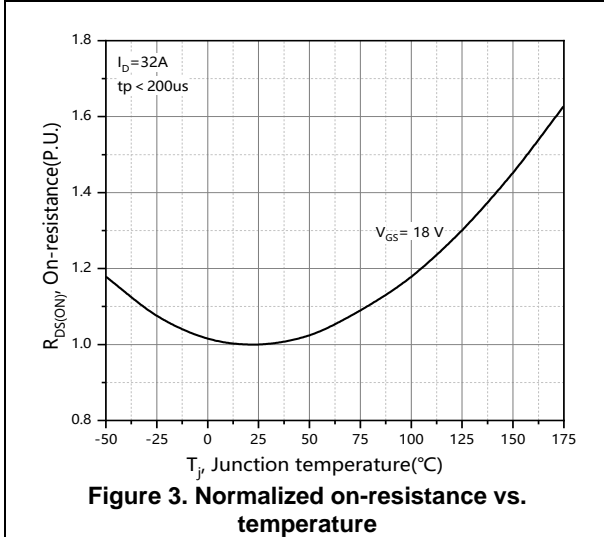
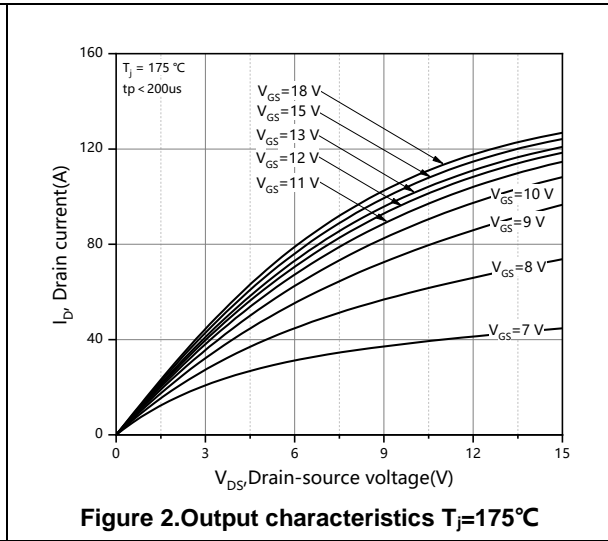
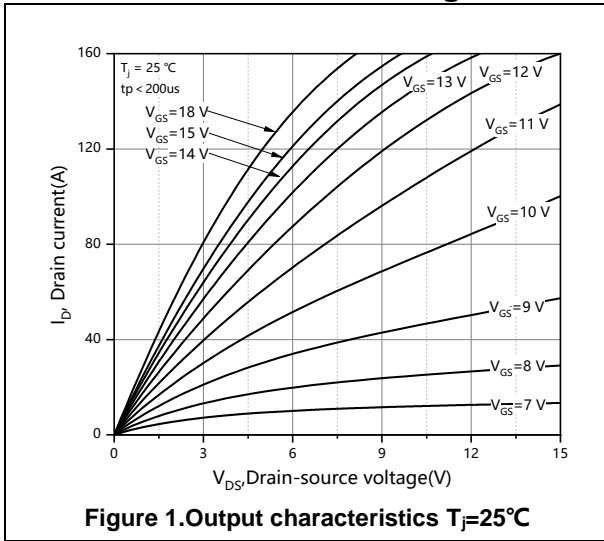

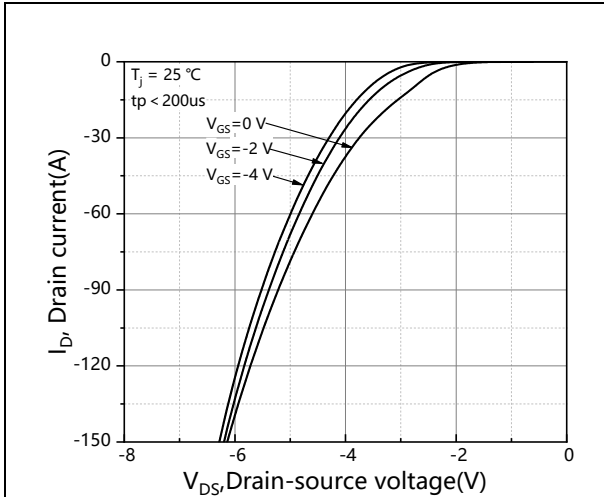

Figure 7. Body diode characteristic at $T_j = 25\text{ }^\circ\text{C}$

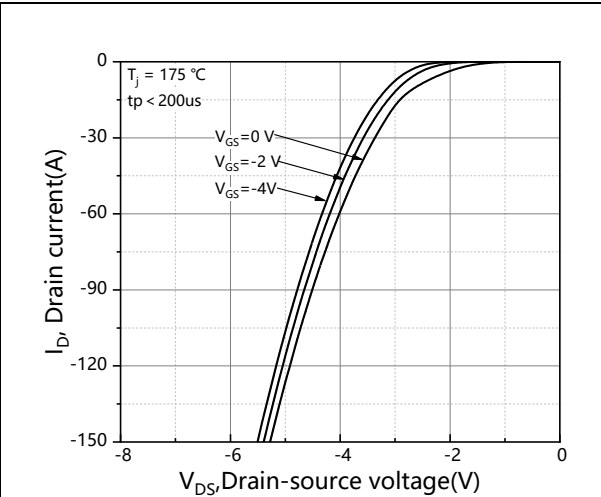

Figure 8. Body diode characteristic at $T_j = 175\text{ }^\circ\text{C}$

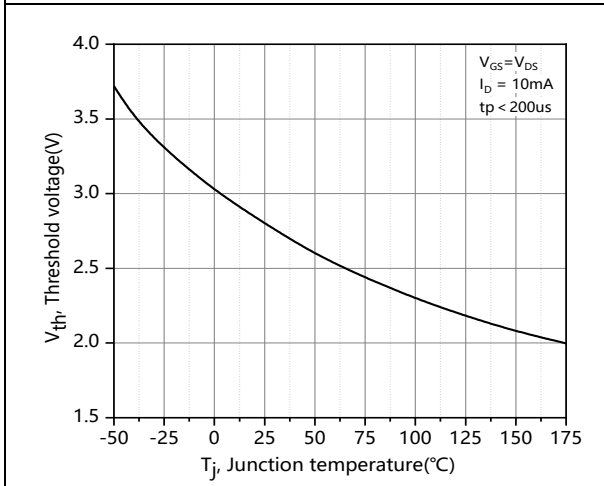

Figure 9. Threshold voltage vs. temperature

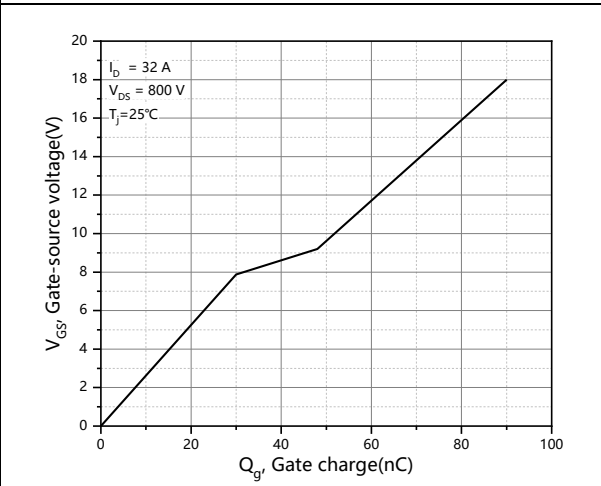

Figure 10. Gate charge characteristic

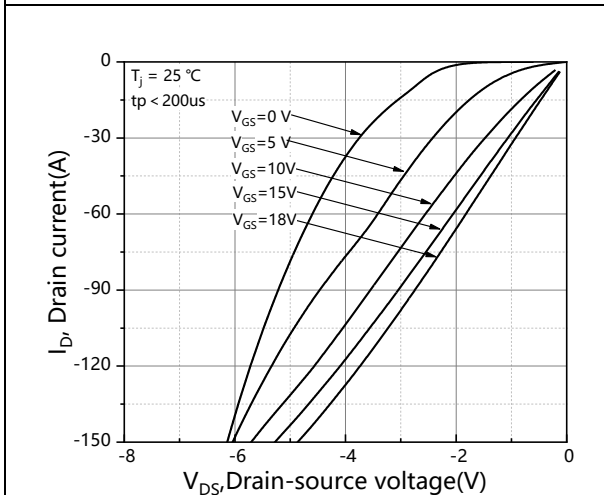

Figure 11. 3rd quadrant characteristic at $T_j = 25\text{ }^\circ\text{C}$

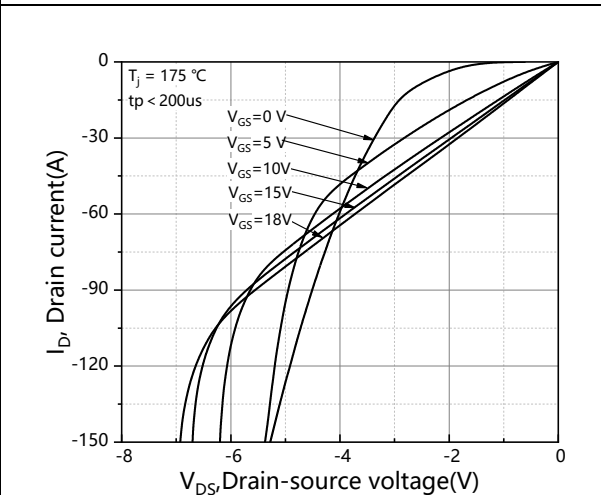
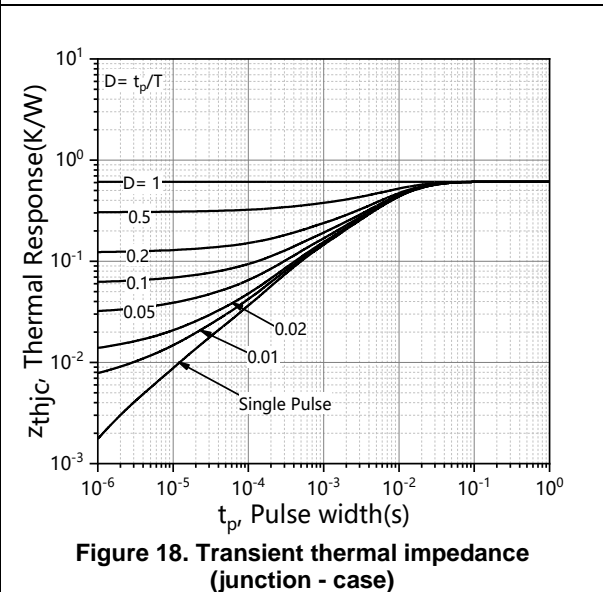
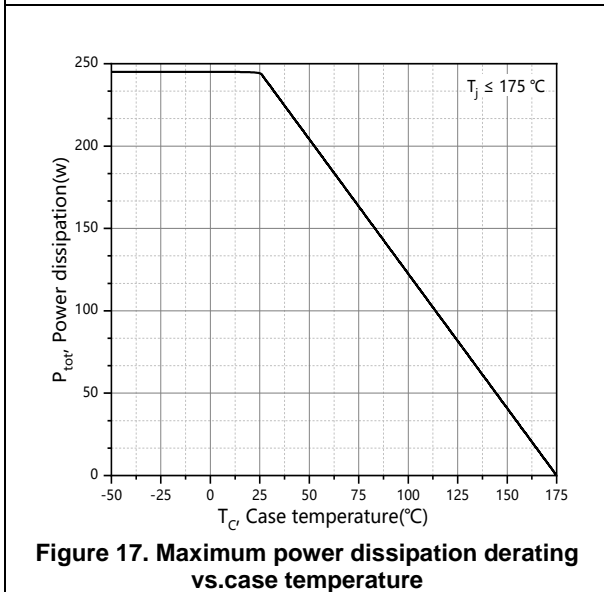
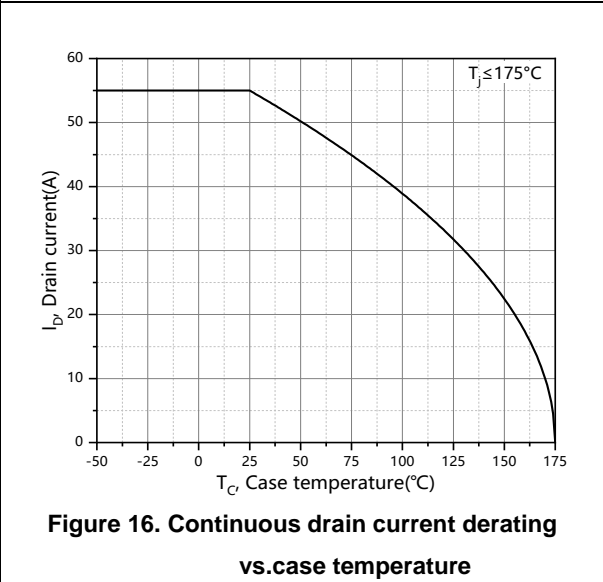
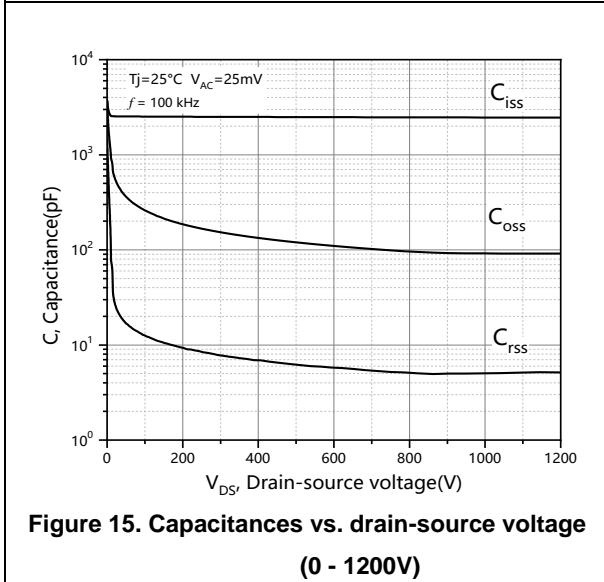
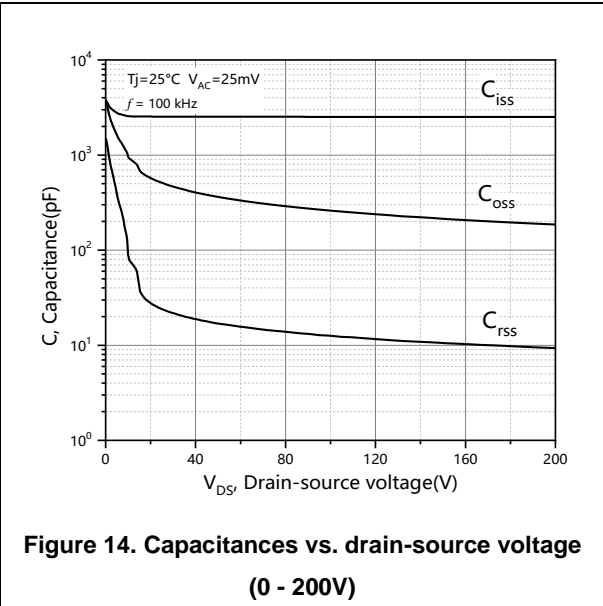
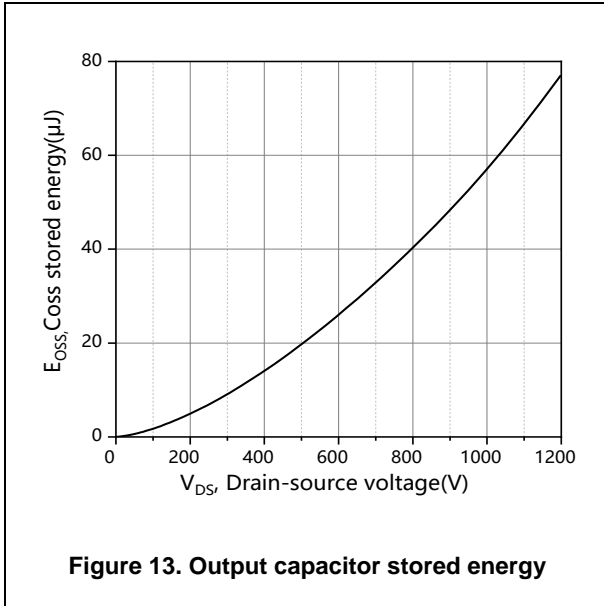
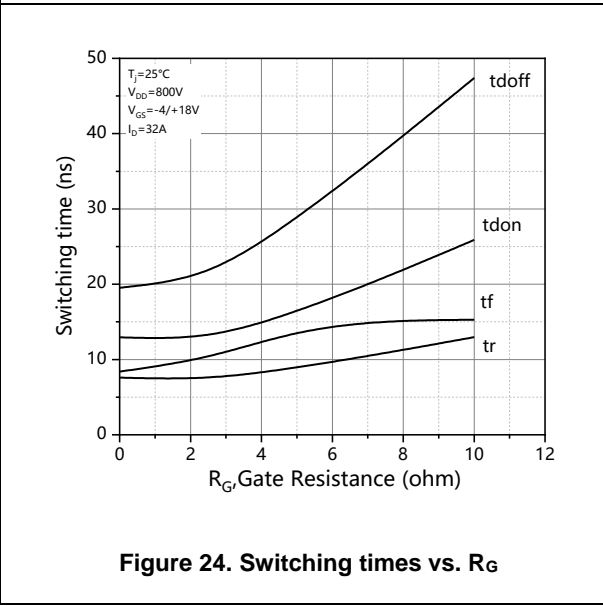
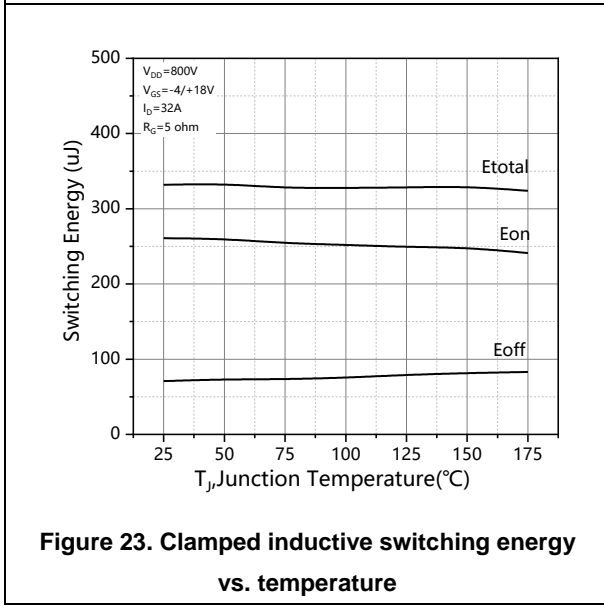
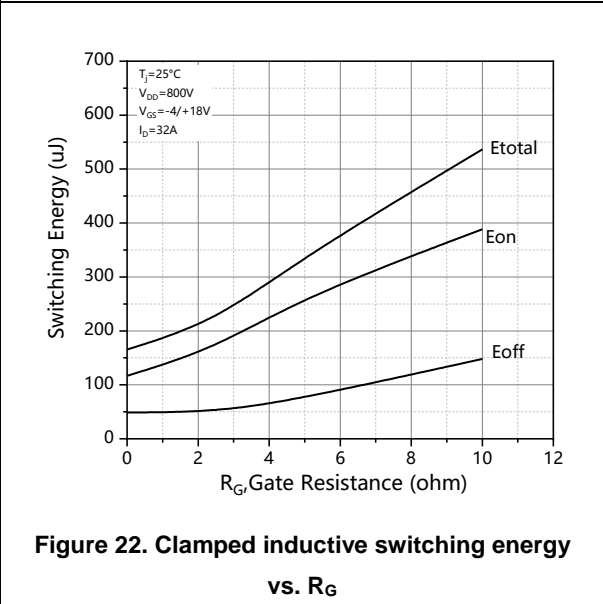
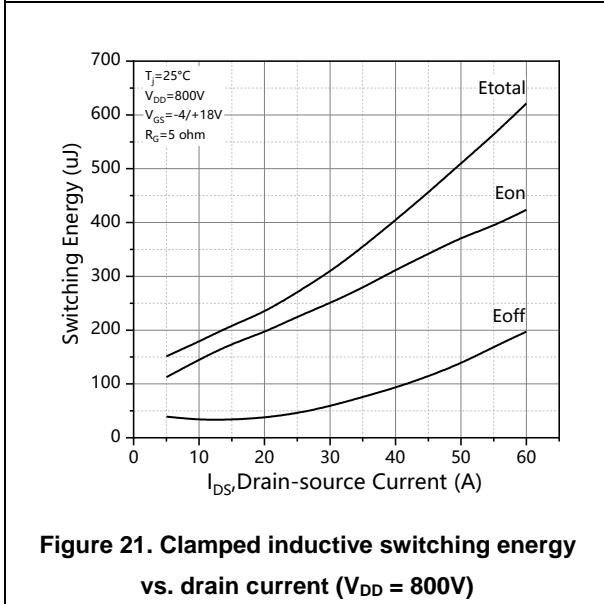
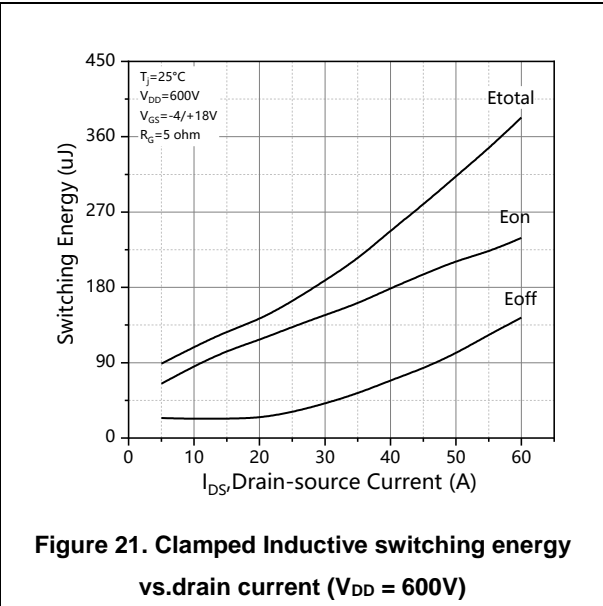
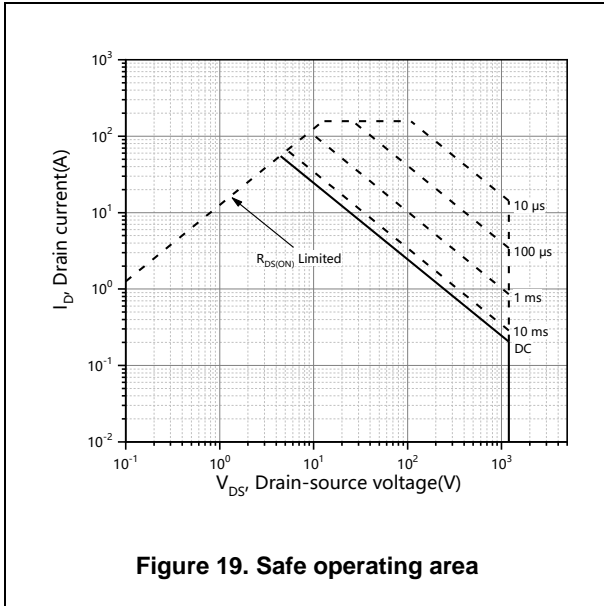
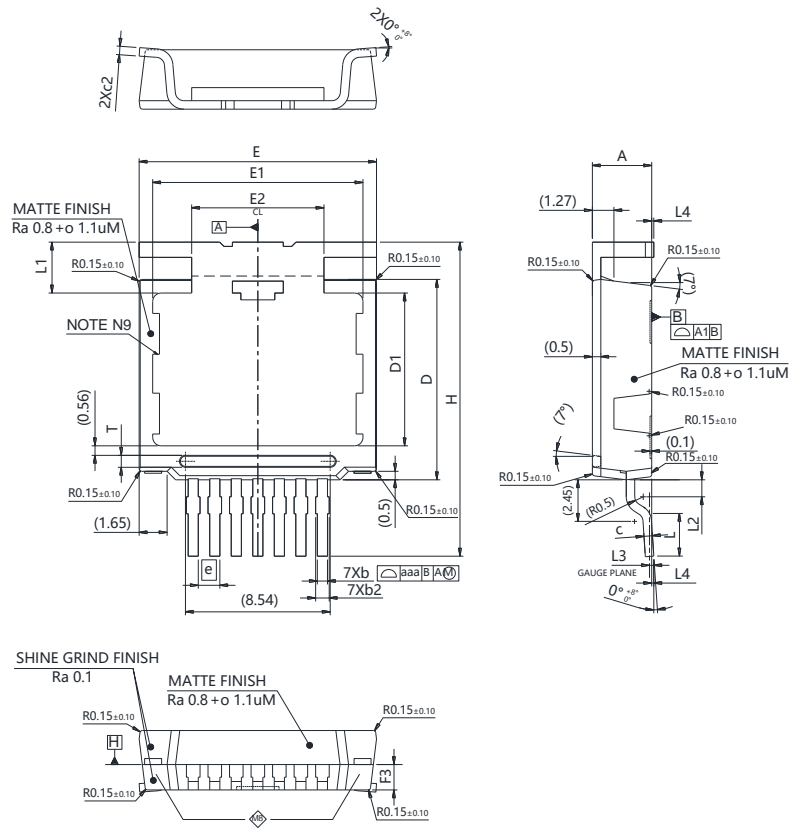

Figure 12. 3rd quadrant characteristic at $T_j = 175\text{ }^\circ\text{C}$







Symbol	mm		Symbol	mm	
	Min	Max		Min	Max
A	3.40	3.60	e	BSC1.27	
A1	0.05		H	18.00	19.00
b	0.50	0.70	L	2.40	2.60
b2	0.50	1.00	L1	3.00	3.20
b3	0.80	1.00	L2	0.90	1.10
c	0.40	0.60	L3	BSC0.26	
c2	0.40	0.60	L4	0.07	0.18
D	11.70	11.90	aaa	0.10	
D1	8.90	9.10	F3	1.40	1.60
E	13.90	14.10	N1	3.80	4.00
E1	12.30	12.50	N2	0.25	0.35
E2	7.75	7.85	N3	0.80	1.00
T	0.60	0.70	b1	0.50	0.65
c1	0.4	0.55	b4	0.50	0.95

Version : T2PAK-S -package outline dimension

Ordering Information

Package Type	Units/ Reel	Reels/ Inner Box	Units/ Inner Box	Inner Boxes/ Carton Box	Units/ Carton Box
T2PAK-S	800	1	800	4	3200

Product Information

Product	Package	Pb Free	RoHS	Halogen Free
OSQ120R035K9T2AF	T2PAK	yes	yes	yes

Legal Disclaimer

The information given in this document shall in no event be regarded as a guarantee of conditions or characteristics. With respect to any examples or hints given herein, any typical values stated herein and/or any information regarding the application of the device, Oriental Semiconductor hereby disclaims any and all warranties and liabilities of any kind, including without limitation, warranties of non-infringement of intellectual property rights of any third party.

For further information on technology, delivery terms and conditions and prices, please contact the Oriental Semiconductor sales representatives (www.orientalsemi.com).

© Oriental Semiconductor Co.,Ltd. All Rights Reserved 

Revision History

Version	Revision History	Date
V1.0	Initial release	2025-07-24