

## General Description

The GreenMOS<sup>®</sup> high voltage MOSFET utilizes charge balance technology to achieve outstanding low on-resistance and lower gate charge. It is engineered to minimize conduction loss, provide superior switching performance and robust avalanche capability.

The GreenMOS<sup>®</sup> S series is optimized for its switching characteristics to achieve aggressive EMI standards. It is easy to use for smaller power supply systems to meet the both efficiency and EMI standards.

## Features

- Low  $R_{DS(ON)}$  & FOM
- Extremely low switching loss
- Excellent stability and uniformity



## Applications

- LED lighting
- Charger
- Adapter
- Telecom power
- Server power
- Solar/UPS

## Key Performance Parameters

Parameter	Value	Unit
$V_{DS}$	650	V
$I_D$ , pulse	24	A
$R_{DS(ON), max}$ @ $V_{GS}=10V$	600	m $\Omega$
$Q_g$	12.7	nC

## Marking Information

Product Name	Package	Marking
OSG65R600FSF_NB	TO220F_NL	OSG65R600FS

## Package & Pin Information

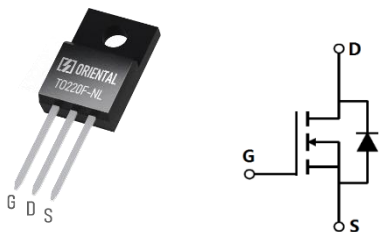

**Absolute Maximum Ratings** at  $T_j=25^{\circ}\text{C}$  unless otherwise noted

Parameter	Symbol	Value	Unit
Drain-source voltage	$V_{DS}$	650	V
Gate-source voltage	$V_{GS}$	$\pm 30$	V
Continuous drain current <sup>1)</sup> , $T_C=25^{\circ}\text{C}$	$I_D$	8	A
Continuous drain current <sup>1)</sup> , $T_C=100^{\circ}\text{C}$		4.5	
Pulsed drain current <sup>2)</sup> , $T_C=25^{\circ}\text{C}$	$I_{D, pulse}$	24	A
Continuous diode forward current <sup>1)</sup> , $T_C=25^{\circ}\text{C}$	$I_S$	8	A
Diode pulsed current <sup>2)</sup> , $T_C=25^{\circ}\text{C}$	$I_{S, pulse}$	24	A
Power dissipation <sup>3)</sup> , $T_C=25^{\circ}\text{C}$	$P_D$	28	W
Single pulsed avalanche energy <sup>4)</sup>	$E_{AS}$	129	mJ
MOSFET dv/dt ruggedness, $V_{DS}=0\dots 480\text{ V}$	dv/dt	50	V/ns
Reverse diode dv/dt, $V_{DS}=0\dots 480\text{ V}$ , $I_{SD}\leq I_D$	dv/dt	15	V/ns
Operation and storage temperature	$T_{stg}, T_j$	-55 to 150	$^{\circ}\text{C}$

**Thermal Characteristics**

Parameter	Symbol	Value	Unit
Thermal resistance, junction-case	$R_{\theta JC}$	4.46	$^{\circ}\text{C/W}$
Thermal resistance, junction-ambient	$R_{\theta JA}$	62.5	$^{\circ}\text{C/W}$

**Electrical Characteristics** at  $T_j=25^{\circ}\text{C}$  unless otherwise specified

Parameter	Symbol	Min.	Typ.	Max.	Unit	Test condition
Drain-source breakdown voltage	$BV_{DSS}$	650			V	$V_{GS}=0\text{ V}$ , $I_D=250\ \mu\text{A}$
Gate threshold voltage	$V_{GS(th)}$	2.9		3.9	V	$V_{DS}=V_{GS}$ , $I_D=250\ \mu\text{A}$
Drain-source on-state resistance	$R_{DS(ON)}$		0.54	0.6	$\Omega$	$V_{GS}=10\text{ V}$ , $I_D=4\text{ A}$
			1.34			$V_{GS}=10\text{ V}$ , $I_D=4\text{ A}$ , $T_j=150^{\circ}\text{C}$
Gate-source leakage current	$I_{GSS}$			100	nA	$V_{GS}=30\text{ V}$
				-100		$V_{GS}=-30\text{ V}$
Drain-source leakage current	$I_{DSS}$			1	$\mu\text{A}$	$V_{DS}=650\text{ V}$ , $V_{GS}=0\text{ V}$
Gate resistance	$R_G$		10.3		$\Omega$	$f=1\text{ MHz}$ , Open drain

### Dynamic Characteristics

Parameter	Symbol	Min.	Typ.	Max.	Unit	Test condition
Input capacitance	$C_{iss}$		551		pF	$V_{GS}=0\text{ V}$ , $V_{DS}=50\text{ V}$ , $f=100\text{ kHz}$
Output capacitance	$C_{oss}$		41		pF	
Reverse transfer capacitance	$C_{rss}$		1.6		pF	
Turn-on delay time	$t_{d(on)}$		20.9		ns	$V_{GS}=10\text{ V}$ , $V_{DS}=400\text{ V}$ , $R_G=2\ \Omega$ , $I_D=4\text{ A}$
Rise time	$t_r$		7.6		ns	
Turn-off delay time	$t_{d(off)}$		40.3		ns	
Fall time	$t_f$		11.3		ns	

### Gate Charge Characteristics

Parameter	Symbol	Min.	Typ.	Max.	Unit	Test condition
Total gate charge	$Q_g$		12.7		nC	$V_{GS}=10\text{ V}$ , $V_{DS}=400\text{ V}$ , $I_D=4\text{ A}$
Gate-source charge	$Q_{gs}$		4.7		nC	
Gate-drain charge	$Q_{gd}$		3.2		nC	
Gate plateau voltage	$V_{plateau}$		5.4		V	

### Body Diode Characteristics

Parameter	Symbol	Min.	Typ.	Max.	Unit	Test condition
Diode forward voltage	$V_{SD}$			1.3	V	$I_S=8\text{ A}$ , $V_{GS}=0\text{ V}$
Reverse recovery time	$t_{rr}$		217		ns	$V_R=400\text{ V}$ , $I_S=4\text{ A}$ , $di/dt=100\text{ A}/\mu\text{s}$
Reverse recovery charge	$Q_{rr}$		1.8		$\mu\text{C}$	
Peak reverse recovery current	$I_{rrm}$		15.1		A	

### Note

- 1) Calculated continuous current based on maximum allowable junction temperature.
- 2) Repetitive rating; pulse width limited by max. junction temperature.
- 3)  $P_d$  is based on max. junction temperature, using junction-case thermal resistance.
- 4)  $V_{DD}=100\text{ V}$ ,  $V_{GS}=10\text{ V}$ ,  $L=79.9\text{ mH}$ , starting  $T_j=25\text{ }^\circ\text{C}$ .

**Electrical Characteristics Diagrams**

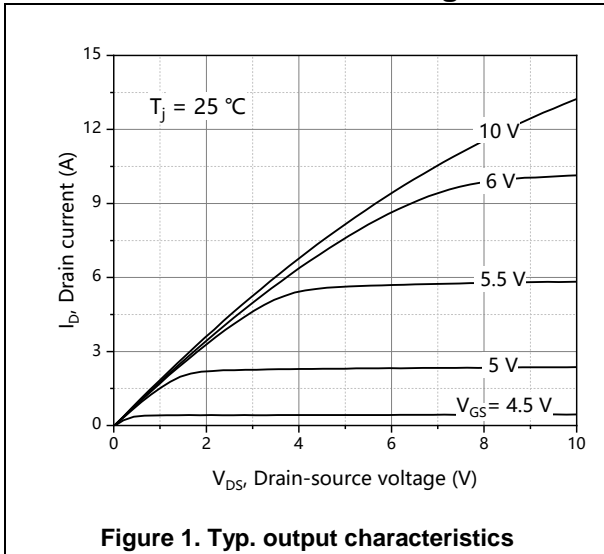

**Figure 1. Typ. output characteristics**

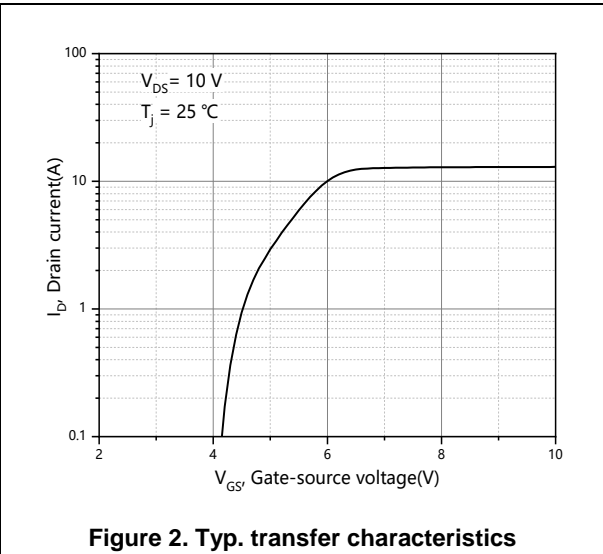

**Figure 2. Typ. transfer characteristics**

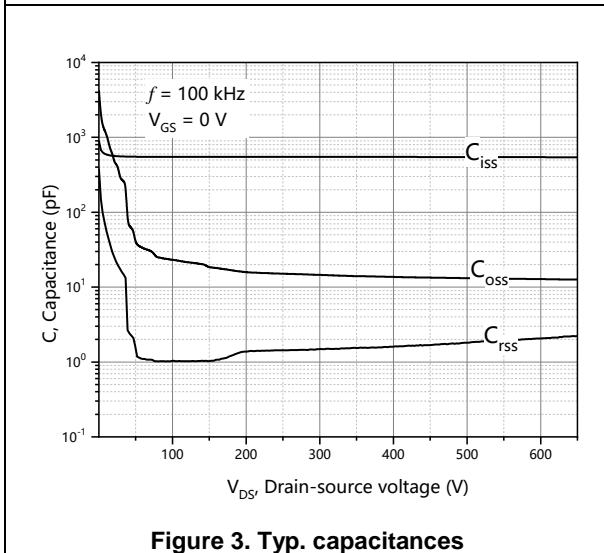

**Figure 3. Typ. capacitances**

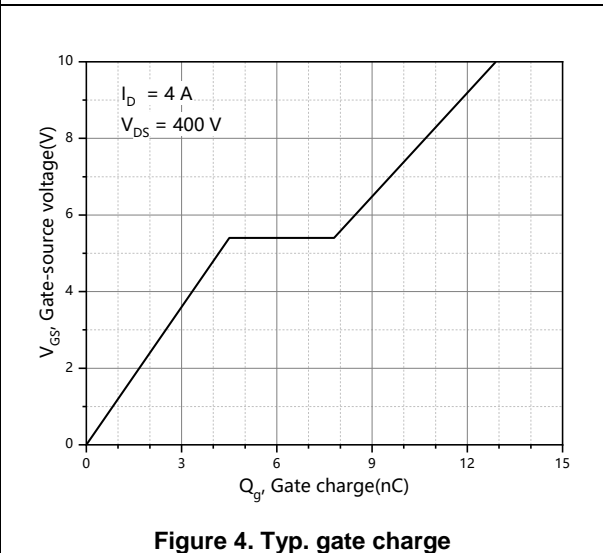

**Figure 4. Typ. gate charge**

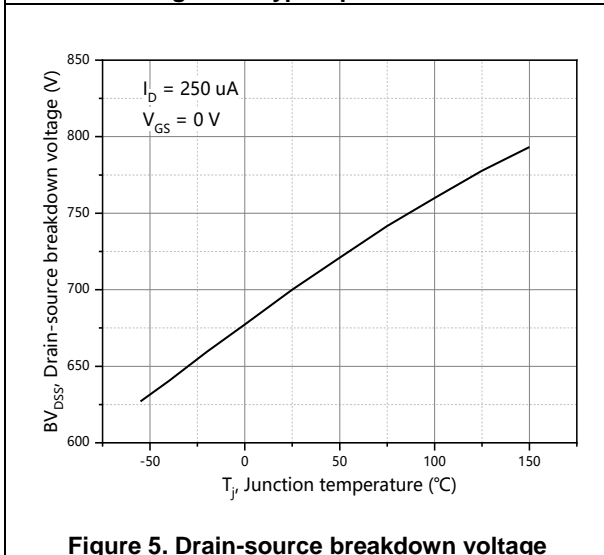

**Figure 5. Drain-source breakdown voltage**

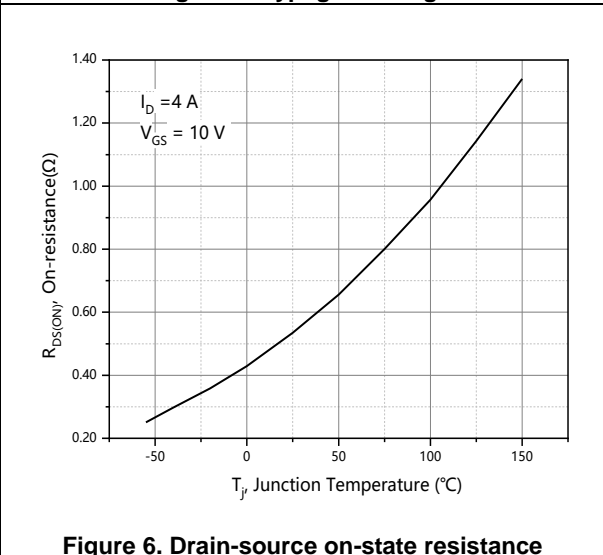

**Figure 6. Drain-source on-state resistance**

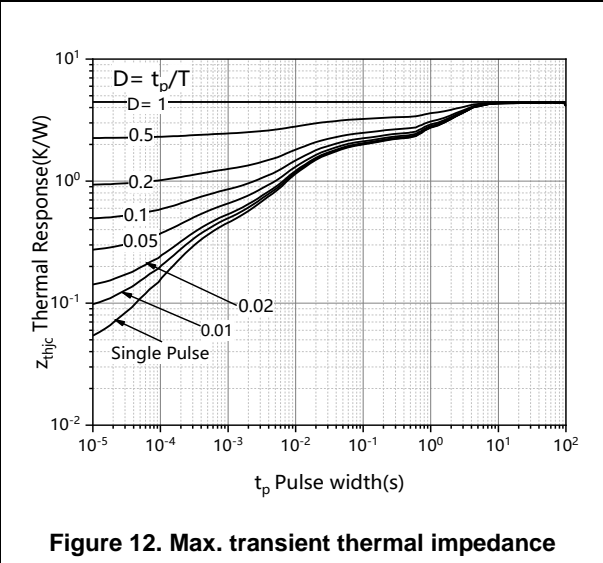
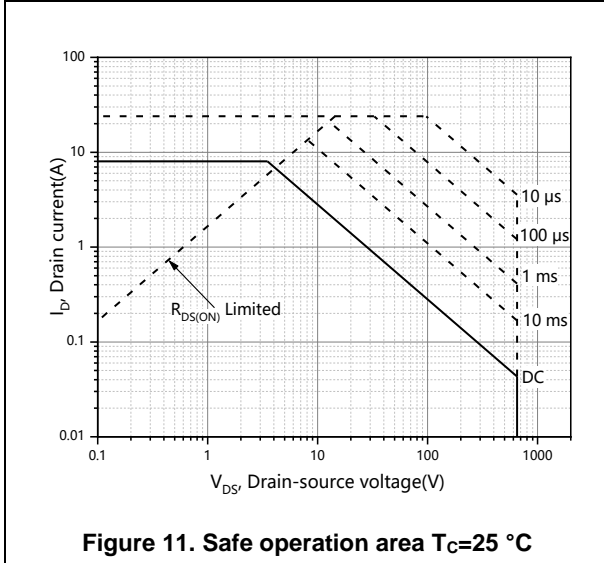
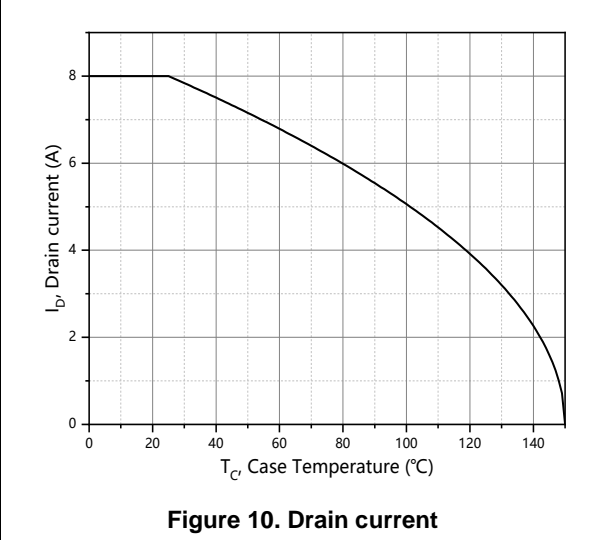
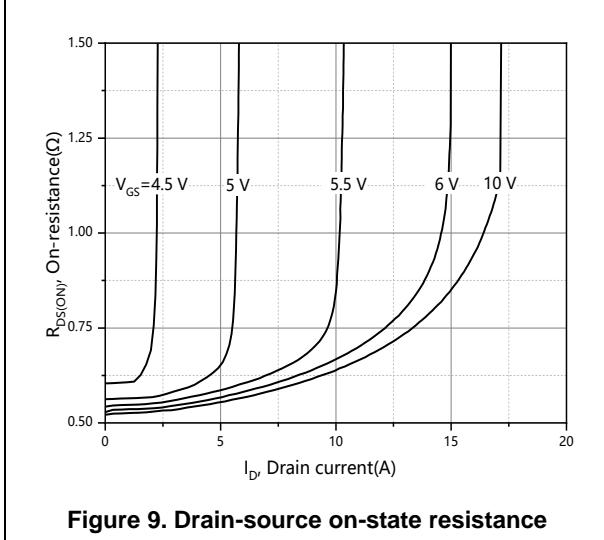
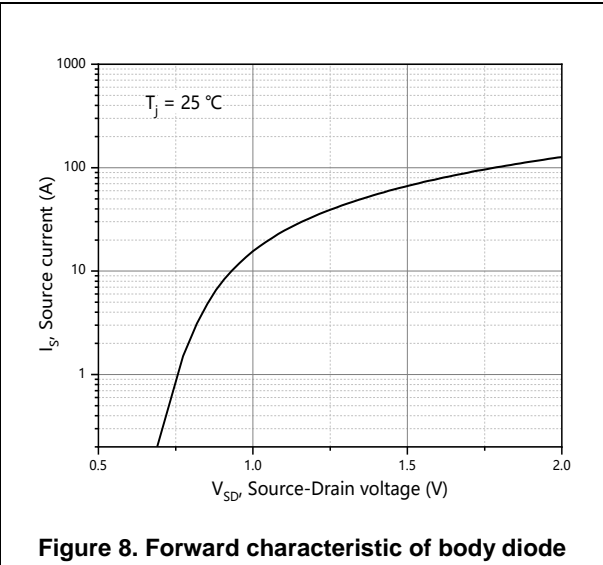
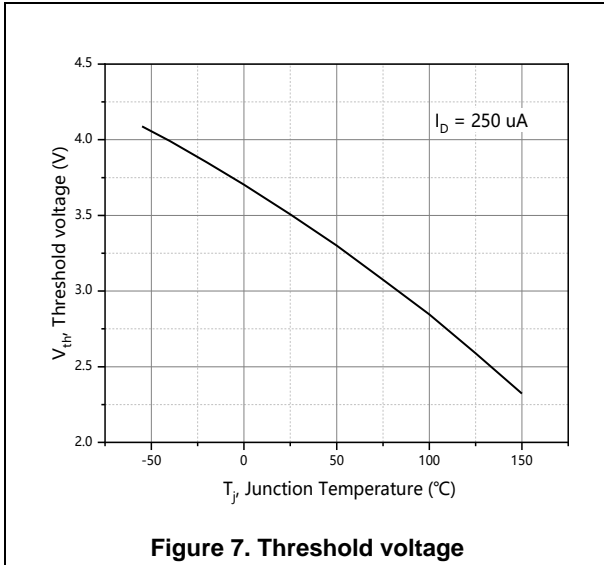

**Test circuits and waveforms**



**Figure 1. Gate charge test circuit & waveform**



**Figure 2. Switching time test circuit & waveforms**

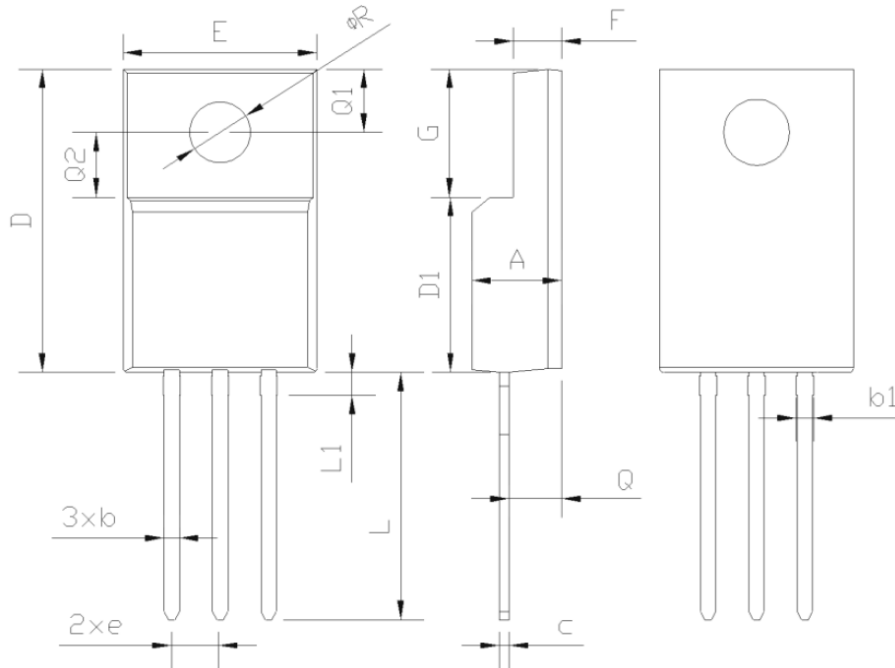

**Figure 3. Unclamped inductive switching (UIS) test circuit & waveforms**



**Figure 4. Diode reverse recovery test circuit & waveforms**

**Package Information**



Symbol	mm		
	Min	Nom	Max
A	4.30	4.50	4.70
b	0.60	0.70	0.80
b1	0.60	0.80	0.90
c	0.45	0.50	0.60
D	14.70	15.00	15.30
D1	8.50REF		
e	2.60BSC		
E	9.70	10.00	10.30
F	2.50	2.70	2.90
G	6.30	6.50	6.70
L	13.40	13.60	13.80
L1	1.00	1.10	1.20
Q	2.50	2.60	2.70
Q1	2.90	3.00	3.10
Q2	3.50REF		
ΦR	3.00	3.20	3.40

Version : TO220F\_NL-M package outline dimension

**Package Information**

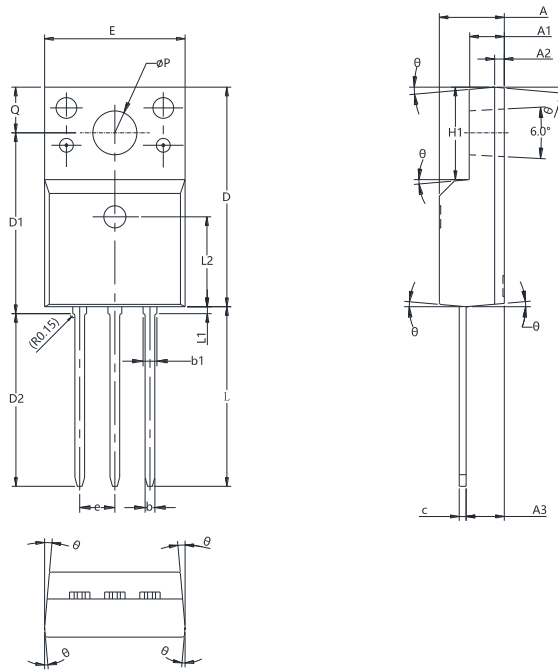

Symbol	mm		
	Min	Nom	Max
A	4.5	4.7	4.83
A1	2.34	2.54	2.74
A2	0.70 REF		
A3	2.56	2.76	2.93
b	0.6	-	0.8
b1	0.9	-	1.1
c	0.45	0.5	0.6
D	15.67	15.87	16.07
D1	12.87	13.07	13.27
D2	12.28	12.48	12.68
E	9.96	10.16	10.36
e	2.54 BSC		
H1	6.48	6.68	6.88
L	12.68	12.98	13.28
L1	-	-	0.85
L2	6.50 REF		
φP	3.08	3.18	3.28
Q	3.20	-	3.40
θ1	1°	3°	5°

Version : TO220F\_NL-J package outline dimension

## Ordering Information

Package Type	Units/ Tube	Tubes/ Inner Box	Units/ Inner Box	Inner Boxes/ Carton Box	Units/ Carton Box
TO220F_NL-M	50	40	2000	4	8000
TO220F_NL-J	50	20	1000	5	5000

## Product Information

Product	Package	Pb Free	RoHS	Halogen Free
OSG65R600FSF_NB	TO220F_NL	yes	yes	yes

## Legal Disclaimer

The information given in this document shall in no event be regarded as a guarantee of conditions or characteristics. With respect to any examples or hints given herein, any typical values stated herein and/or any information regarding the application of the device, Oriental Semiconductor hereby disclaims any and all warranties and liabilities of any kind, including without limitation, warranties of non-infringement of intellectual property rights of any third party.

For further information on technology, delivery terms and conditions and prices, please contact the Oriental Semiconductor sales representatives ([www.orientalsemi.com](http://www.orientalsemi.com)).

© Oriental Semiconductor Co.,Ltd. All Rights Reserved 

## Revision History

Version	Revision History	Date
V2.0	Initial release	2019-11-01
V2.1	Update ordering information assembly site "M"	2026-05-07