

## General Description

The GreenMOS<sup>®</sup> high voltage MOSFET utilizes charge balance technology to achieve outstanding low on-resistance and lower gate charge. It is engineered to minimize conduction loss, provide superior switching performance and robust avalanche capability.

The GreenMOS<sup>®</sup> Generic series is optimized for extreme switching performance to minimize switching loss. It is tailored for high power density applications to meet the highest efficiency standards.

## Features

- Low  $R_{DS(ON)}$  & FOM
- Extremely low switching loss
- Excellent stability and uniformity



## Applications

- LED lighting
- Telecom
- Adapter
- Sever
- Solar/UPS

## Key Performance Parameters

Parameter	Value	Unit
$V_{DS}$	650	V
$I_{D, pulse}$	33	A
$R_{DS(ON), max} @ V_{GS}=10V$	360	m $\Omega$
$Q_g$	12.6	nC
PD	81	W

## Marking Information

Product Name	Package	Marking
OSG65R360DT4F	TO252	OSG65R360DT4

## Package & Pin Information

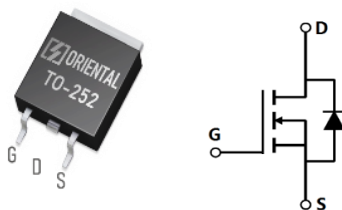

**Absolute Maximum Ratings** at  $T_j=25^\circ\text{C}$  unless otherwise noted

PARAMETER	SYMBOL	VALUE	UNIT
Drain-source voltage	$V_{DS}$	650	V
Gate-source voltage (static)	$V_{GS}$	$\pm 20$	V
Gate-source voltage (dynamic)		$\pm 30$	V
Continuous drain current <sup>1)</sup> , $T_C=25^\circ\text{C}$	$I_D$	11	A
Continuous drain current <sup>1)</sup> , $T_C=100^\circ\text{C}$		7	
Pulsed drain current <sup>2)</sup> , $T_C=25^\circ\text{C}$	$I_{D, pulse}$	33	A
Continuous diode forward current <sup>1)</sup> , $T_C=25^\circ\text{C}$	$I_S$	11	A
Diode pulsed current <sup>2)</sup> , $T_C=25^\circ\text{C}$	$I_{S, pulse}$	33	A
Power dissipation <sup>3)</sup> , $T_C=25^\circ\text{C}$	$P_D$	81	W
Single pulsed avalanche energy <sup>5)</sup>	$E_{AS}$	91	mJ
MOSFET dv/dt ruggedness, $V_{DS}=0\dots 400\text{ V}$	dv/dt	50	V/ns
Reverse diode dv/dt, $V_{DS}=0\dots 400\text{ V}$ , $I_{SD}\leq I_D$	dv/dt	15	V/ns
Operation and storage temperature	$T_{stg}, T_j$	-55 to 150	$^\circ\text{C}$

**Thermal Characteristics**

PARAMETER	SYMBOL	VALUE	UNIT
Thermal resistance, junction-case	$R_{\theta JC}$	1.54	$^\circ\text{C/W}$
Thermal resistance, junction-ambient <sup>4)</sup>	$R_{\theta JA}$	62	$^\circ\text{C/W}$

**Electrical Characteristics** at  $T_j=25^\circ\text{C}$  unless otherwise specified

PARAMETER	SYMBOL	MIN.	TYP.	MAX.	UNIT	TEST CONDITION
Drain-source breakdown voltage	$BV_{DSS}$	650			V	$V_{GS}=0\text{ V}$ , $I_D=250\ \mu\text{A}$
Gate threshold voltage	$V_{GS(th)}$	2.9		3.9	V	$V_{DS}=V_{GS}$ , $I_D=250\ \mu\text{A}$
Drain-source on-state resistance	$R_{DS(ON)}$		302	360	m $\Omega$	$V_{GS}=10\text{ V}$ , $I_D=5.5\text{ A}$
			788			$V_{GS}=10\text{ V}$ , $I_D=5.5\text{ A}$ , $T_j=150^\circ\text{C}$
Gate-source leakage current	$I_{GSS}$			100	nA	$V_{GS}=20\text{ V}$
				-100		$V_{GS}=-20\text{ V}$
Drain-source leakage current	$I_{DSS}$			1	$\mu\text{A}$	$V_{DS}=650\text{ V}$ , $V_{GS}=0\text{ V}$
Gate resistance	$R_G$		30		$\Omega$	$f=1\text{ MHz}$ , Open drain

### Dynamic Characteristics

PARAMETER	SYMBOL	MIN.	TYP.	MAX.	UNIT	TEST CONDITION
Input capacitance	$C_{iss}$		546		pF	$V_{GS}=0\text{ V}$ , $V_{DS}=50\text{ V}$ , $f=100\text{ kHz}$
Output capacitance	$C_{oss}$		37		pF	
Reverse transfer capacitance	$C_{rss}$		1.5		pF	
Effective output capacitance, energy related	$C_{o(er)}$		28.5		pF	$V_{GS}=0\text{ V}$ , $V_{DS}=0\text{ V}-400\text{ V}$
Effective output capacitance, time related	$C_{o(tr)}$		154		pF	
Turn-on delay time	$t_{d(on)}$		12		ns	$V_{GS}=10\text{ V}$ , $V_{DS}=400\text{ V}$ , $R_G=2\ \Omega$ , $I_D=6\text{ A}$
Rise time	$t_r$		15.8		ns	
Turn-off delay time	$t_{d(off)}$		50		ns	
Fall time	$t_f$		12		ns	

### Gate Charge Characteristics

PARAMETER	SYMBOL	MIN.	TYP.	MAX.	UNIT	TEST CONDITION
Total gate charge	$Q_g$		12.6		nC	$V_{GS}=10\text{ V}$ , $V_{DS}=400\text{ V}$ , $I_D=6\text{ A}$
Gate-source charge	$Q_{gs}$		2.6		nC	
Gate-drain charge	$Q_{gd}$		5		nC	
Gate plateau voltage	$V_{plateau}$		5.4		V	

### Body Diode Characteristics

PARAMETER	SYMBOL	MIN.	TYP.	MAX.	UNIT	TEST CONDITION
Diode forward voltage	$V_{SD}$			1.3	V	$I_S=11\text{ A}$ , $V_{GS}=0\text{ V}$
Reverse recovery time	$t_{rr}$		183		ns	$V_R=400\text{ V}$ , $I_S=6\text{ A}$ , $di/dt=100\text{ A}/\mu\text{s}$
Reverse recovery charge	$Q_{rr}$		1.43		$\mu\text{C}$	
Peak reverse recovery current	$I_{rrm}$		14.5		A	

### Note

- 1) Calculated continuous current based on maximum allowable junction temperature.
- 2) Repetitive rating; pulse width limited by max. junction temperature.
- 3)  $P_d$  is based on max. junction temperature, using junction-case thermal resistance.
- 4) The value of  $R_{\theta JA}$  is measured with the device mounted on 1 in<sup>2</sup> FR-4 board with 2oz. Copper, in a still air environment with  $T_a=25\text{ }^\circ\text{C}$ .
- 5)  $V_{DD}=100\text{ V}$ ,  $V_{GS}=10\text{ V}$ ,  $L=80\text{ mH}$ , starting  $T_j=25\text{ }^\circ\text{C}$ .

**Electrical Characteristics Diagrams**

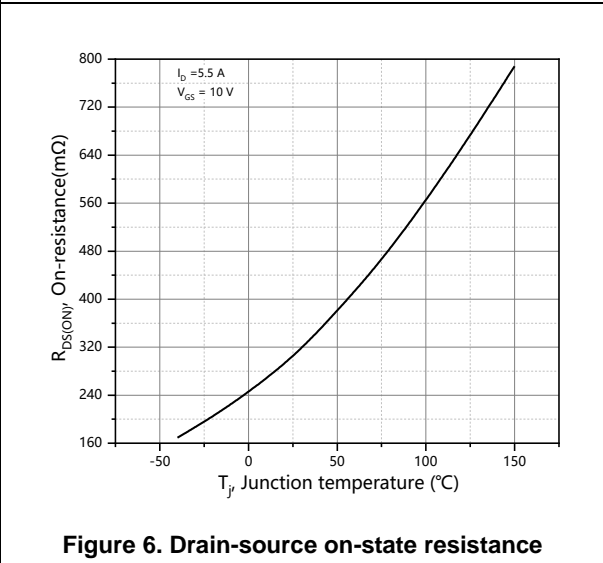
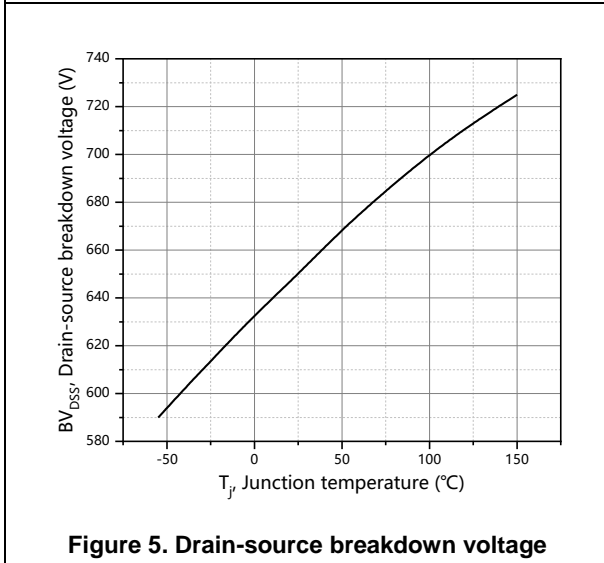
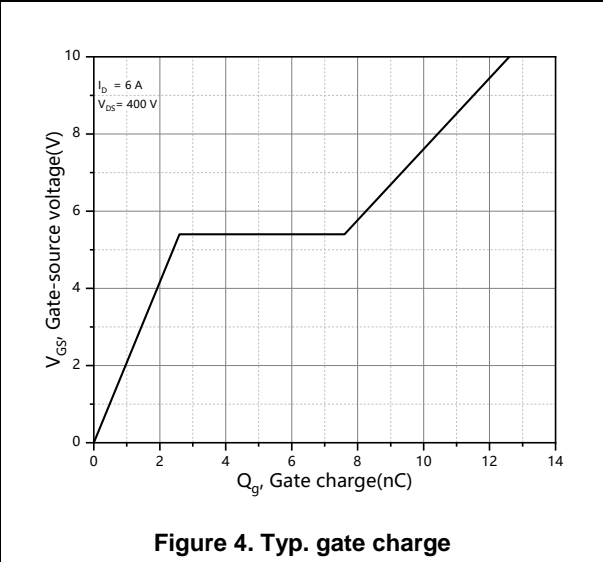
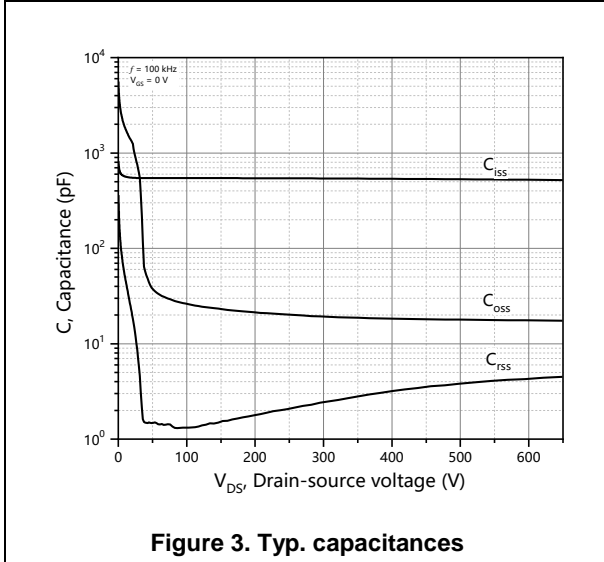
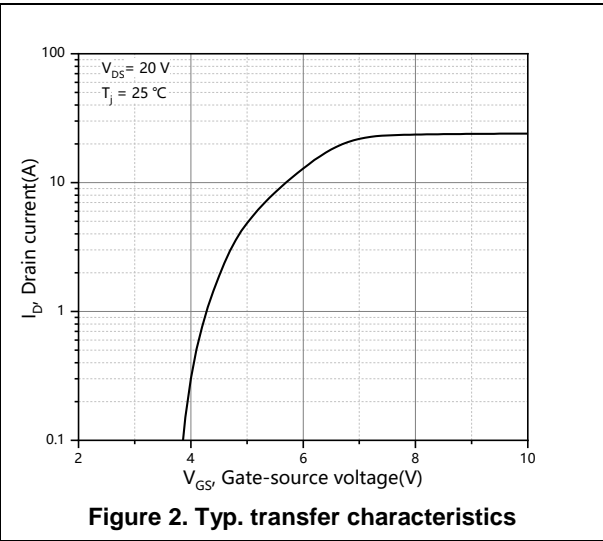
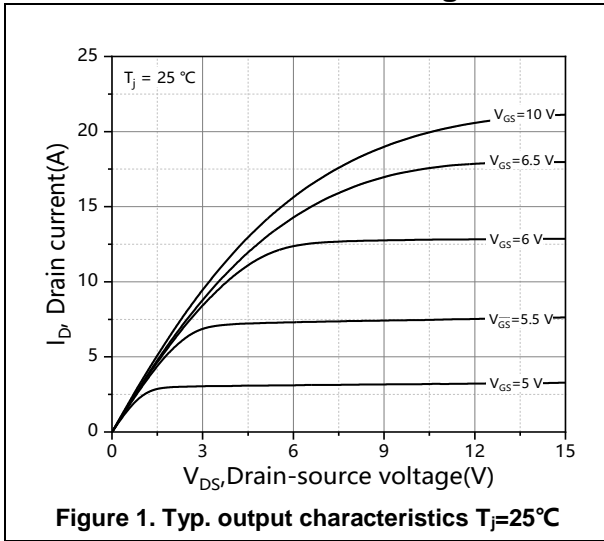

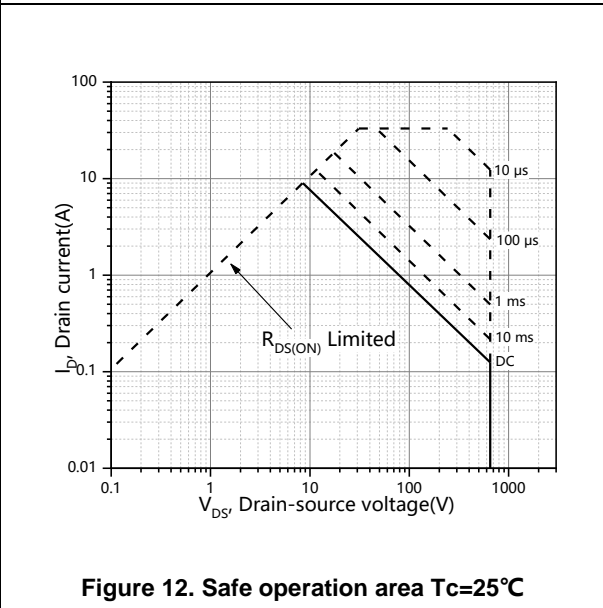
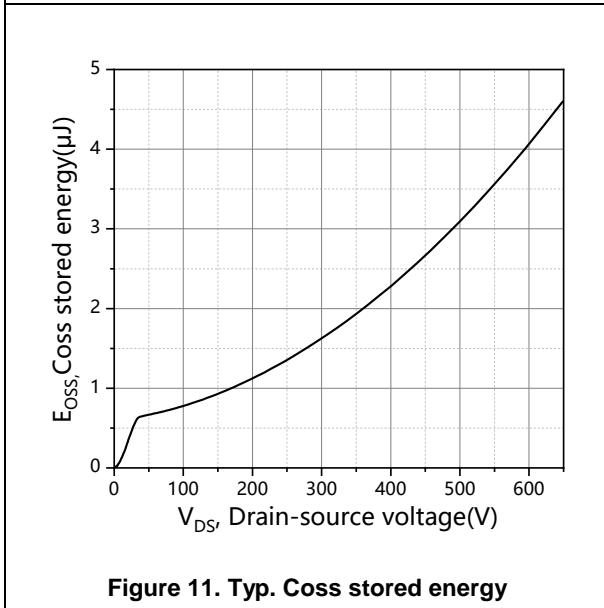
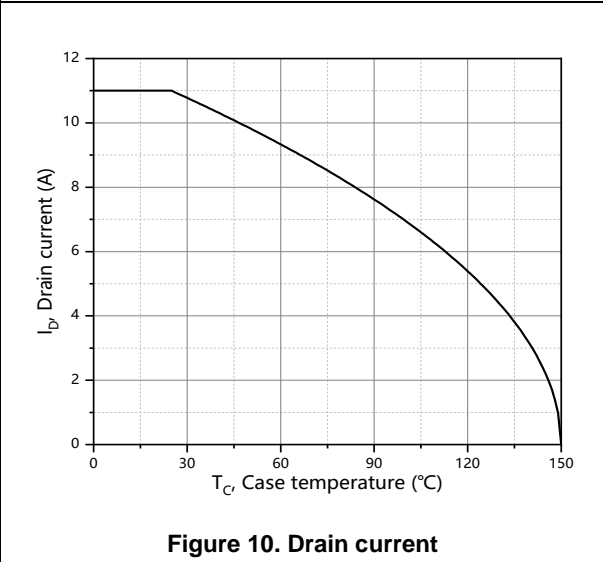
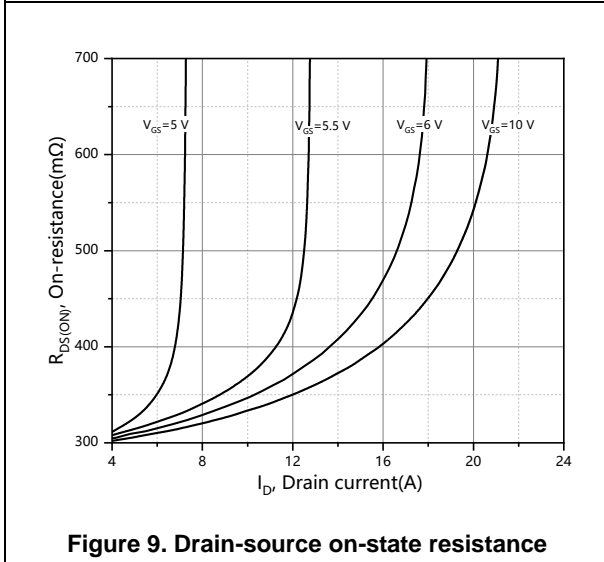
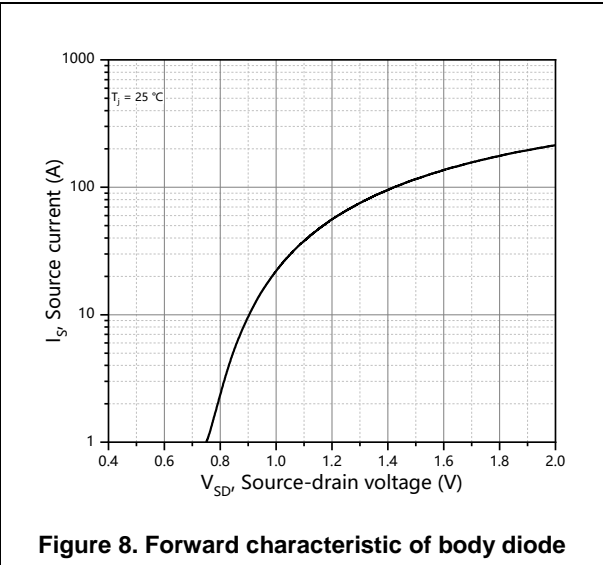
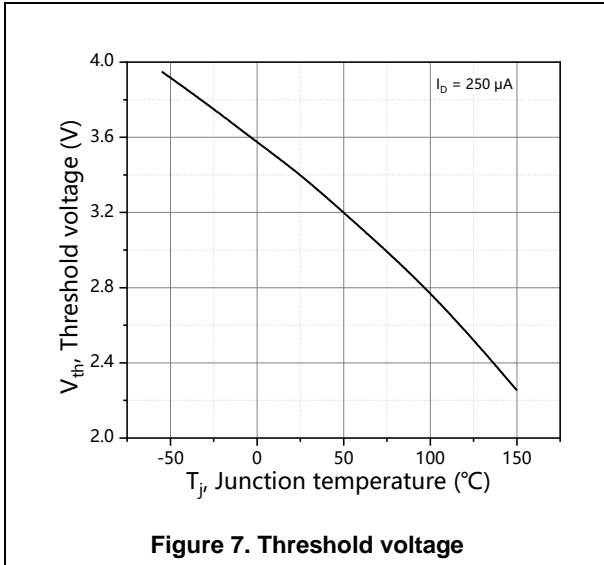

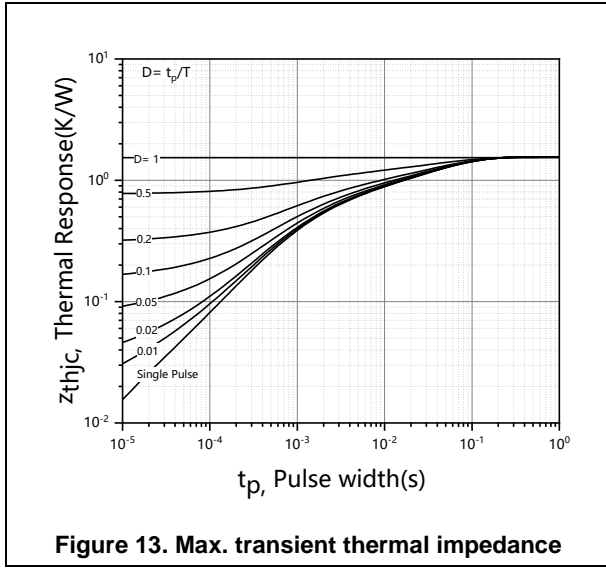

**Test circuits and waveforms**



**Figure 1. Gate charge test circuit & waveform**



**Figure 2. Switching time test circuit & waveforms**

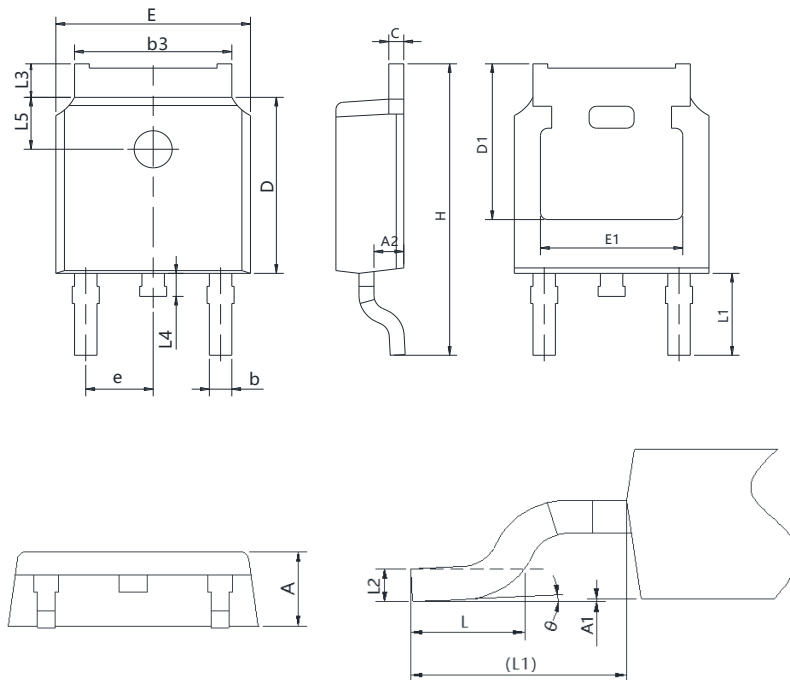

**Figure 3. Unclamped inductive switching (UIS) test circuit & waveforms**



**Figure 4. Diode reverse recovery test circuit & waveforms**

**Package Information**



Symbol	mm		
	Min	Nom	Max
A	2.20	2.30	2.38
A1	0.00	-	0.20
A2	0.97	1.07	1.17
b	0.68	0.78	0.90
b3	5.20	5.33	5.46
c	0.43	0.53	0.61
D	5.98	6.10	6.22
D1	5.30 REF		
E	6.40	6.60	6.73
E1	4.63	-	-
e	2.286 BSC		
H	9.40	10.10	10.50
L	1.38	1.50	1.75
L1	2.90 REF		
L2	0.51 BSC		
L3	0.88	-	1.28
L4	0.50	-	1.00
L5	1.65	1.80	1.95
θ	0°	-	8°

Version: TO252-P package outline dimension

### Ordering Information

Package Type	Units/ Reel	Reels/ Inner Box	Units/ Inner Box	Inner Boxes/ Carton Box	Units/ Carton Box
TO252-P	2500	2	5000	5	25000

### Product Information

Product	Package	Pb Free	RoHS	Halogen Free
OSG65R360DT4F	TO252	yes	yes	yes

### Legal Disclaimer

The information given in this document shall in no event be regarded as a guarantee of conditions or characteristics. With respect to any examples or hints given herein, any typical values stated herein and/or any information regarding the application of the device, Oriental Semiconductor hereby disclaims any and all warranties and liabilities of any kind, including without limitation, warranties of non-infringement of intellectual property rights of any third party.

For further information on technology, delivery terms and conditions and prices, please contact the Oriental Semiconductor sales representatives ([www.orientalsemi.com](http://www.orientalsemi.com)).

© Oriental Semiconductor Co.,Ltd. All Rights Reserved 