

## General Description

The GreenMOS<sup>®</sup> high voltage MOSFET utilizes charge balance technology to achieve outstanding low on-resistance and lower gate charge. It is engineered to minimize conduction loss, provide superior switching performance and robust avalanche capability.

The GreenMOS<sup>®</sup> Z series is integrated with fast recovery diode (FRD) to minimize reverse recovery time. It is suitable for resonant switching topologies to reach higher efficiency, higher reliability and smaller form factor.

## Features

- Low  $R_{DS(ON)}$  & FOM
- Extremely low switching loss
- Excellent stability and uniformity
- AEC-Q101 Qualified for Automotive Application

**GreenMOS<sup>®</sup>**



## Applications

- LED lighting
- Telecom
- Adapter
- Sever
- Solar/UPS

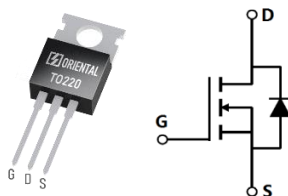
## Key Performance Parameters

Parameter	Value	Unit
$V_{DS}$	650	V
$I_D$ , pulse	120	A
$R_{DS(ON), max}$ @ $V_{GS}=10V$	99	m $\Omega$
$Q_g$	53	nC
PD	190	W

## Marking Information

Product Name	Package	Marking
OSG65R099PT3ZAF-F	TO220	OSG65R099PT3ZA

## Package & Pin Information



**Absolute Maximum Ratings** at  $T_j=25^{\circ}\text{C}$  unless otherwise noted

Parameter	Symbol	Value	Unit
Drain-source voltage	$V_{DS}$	650	V
Gate source voltage (static)	$V_{GS}$	$\pm 20$	V
Gate source voltage (dynamic)		$\pm 30$	V
Continuous drain current <sup>1)</sup> , $T_C=25^{\circ}\text{C}$	$I_D$	40	A
Continuous drain current <sup>1)</sup> , $T_C=100^{\circ}\text{C}$		25.3	
Pulsed drain current <sup>2)</sup> , $T_C=25^{\circ}\text{C}$	$I_{D, pulse}$	120	A
Continuous diode forward current <sup>1)</sup> , $T_C=25^{\circ}\text{C}$	$I_S$	40	A
Diode pulsed current <sup>2)</sup> , $T_C=25^{\circ}\text{C}$	$I_{S, pulse}$	120	A
Power dissipation <sup>3)</sup> , $T_C=25^{\circ}\text{C}$	$P_D$	190	W
Single pulsed avalanche energy <sup>5)</sup>	$E_{AS}$	387	mJ
MOSFET dv/dt ruggedness, $V_{DS}=0\dots 480\text{ V}$	dv/dt	50	V/ns
Reverse diode dv/dt, $V_{DS}=0\dots 480\text{ V}$ , $I_{SD}\leq I_D$	dv/dt	50	V/ns
Operation and storage temperature	$T_{stg}, T_j$	-55 to 150	$^{\circ}\text{C}$

**Thermal Characteristics**

Parameter	Symbol	Value	Unit
Thermal resistance, junction-case <sup>4)</sup>	$R_{\theta JC}$	0.66	$^{\circ}\text{C/W}$
Thermal resistance, junction-ambient	$R_{\theta JA}$	62	$^{\circ}\text{C/W}$

**Electrical Characteristics** at  $T_j=25^{\circ}\text{C}$  unless otherwise specified

Parameter	Symbol	Min.	Typ.	Max.	Unit	Test condition
Drain-source breakdown voltage	$BV_{DSS}$	650			V	$V_{GS}=0\text{ V}$ , $I_D=1\text{ mA}$
Gate threshold voltage	$V_{GS(th)}$	3.5		5.5	V	$V_{DS}=V_{GS}$ , $I_D=1\text{ mA}$
Drain-source on-state resistance	$R_{DS(ON)}$		81	99	m $\Omega$	$V_{GS}=10\text{ V}$ , $I_D=20\text{ A}$
			208			$V_{GS}=10\text{ V}$ , $I_D=20\text{ A}$ , $T_j=150^{\circ}\text{C}$
Gate-source leakage current	$I_{GSS}$			100	nA	$V_{GS}=20\text{ V}$
				-100		$V_{GS}=-20\text{ V}$
Drain-source leakage current	$I_{DSS}$			10	$\mu\text{A}$	$V_{DS}=650\text{ V}$ , $V_{GS}=0\text{ V}$
Gate resistance	$R_G$		13.5		$\Omega$	$f=1\text{ MHz}$ , Open drain

### Dynamic Characteristics

Parameter	Symbol	Min.	Typ.	Max.	Unit	Test condition
Input capacitance	$C_{iss}$		2616		pF	$V_{GS}=0\text{ V}$ , $V_{DS}=50\text{ V}$ , $f=100\text{ kHz}$
Output capacitance	$C_{oss}$		134		pF	
Reverse transfer capacitance	$C_{rss}$		3.9		pF	
Effective output capacitance, energy related	$C_{o(er)}$		88		pF	$V_{GS}=0\text{ V}$ , $V_{DS}=0\text{ V-400 V}$
Effective output capacitance, time related	$C_{o(tr)}$		510		pF	
Turn-on delay time	$t_{d(on)}$		35		ns	$V_{GS}=10\text{ V}$ , $V_{DS}=400\text{ V}$ , $R_G=2\ \Omega$ , $I_D=40\text{ A}$
Rise time	$t_r$		151		ns	
Turn-off delay time	$t_{d(off)}$		62		ns	
Fall time	$t_f$		49		ns	

### Gate Charge Characteristics

Parameter	Symbol	Min.	Typ.	Max.	Unit	Test condition
Total gate charge	$Q_g$		53		nC	$V_{GS}=10\text{ V}$ , $V_{DS}=400\text{ V}$ , $I_D=40\text{ A}$
Gate-source charge	$Q_{gs}$		18		nC	
Gate-drain charge	$Q_{gd}$		22		nC	
Gate plateau voltage	$V_{plateau}$		7.9		V	

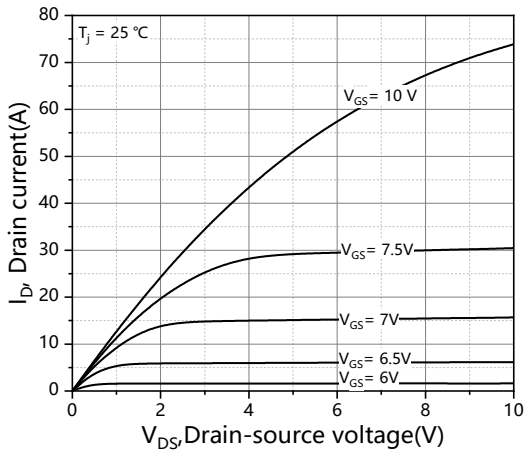
### Body Diode Characteristics

Parameter	Symbol	Min.	Typ.	Max.	Unit	Test condition
Diode forward voltage	$V_{SD}$			1.3	V	$I_S=40\text{ A}$ , $V_{GS}=0\text{ V}$
Reverse recovery time	$t_{rr}$		146		ns	$V_R=400\text{ V}$ , $I_S=40\text{ A}$ , $di/dt=100\text{ A}/\mu\text{s}$
Reverse recovery charge	$Q_{rr}$		1.0		$\mu\text{C}$	
Peak reverse recovery current	$I_{rrm}$		14.4		A	

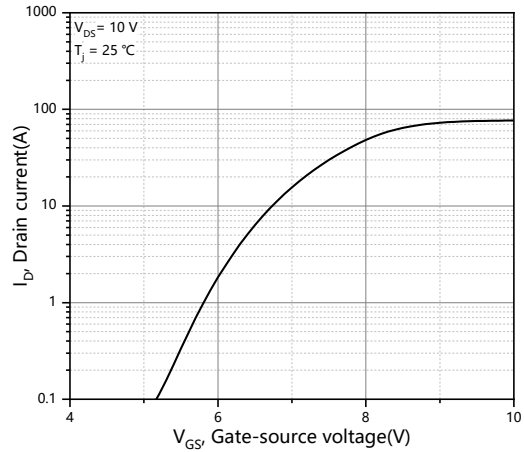
### Note

- 1) Calculated continuous current based on maximum allowable junction temperature.
- 2) Repetitive rating; pulse width limited by max. junction temperature.
- 3)  $P_d$  is based on max. junction temperature, using junction-case thermal resistance.
- 4) The value of  $R_{\theta JA}$  is measured with the device mounted on 1 in<sup>2</sup> FR-4 board with 2oz. Copper, in a still air environment with  $T_a=25\text{ }^\circ\text{C}$ .
- 5)  $V_{DD}=100\text{ V}$ ,  $V_{GS}=10\text{ V}$ ,  $L=80\text{ mH}$ , starting  $T_j=25\text{ }^\circ\text{C}$ .

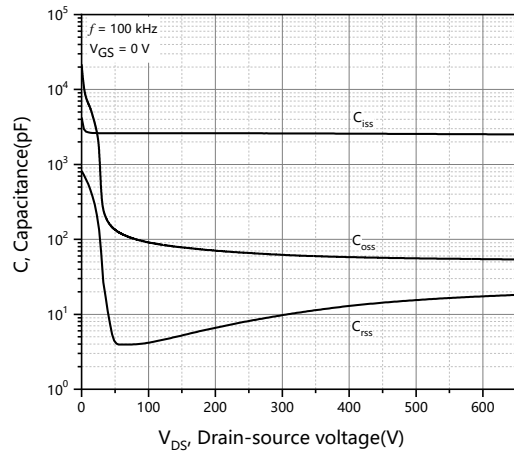
**Electrical Characteristics Diagrams**



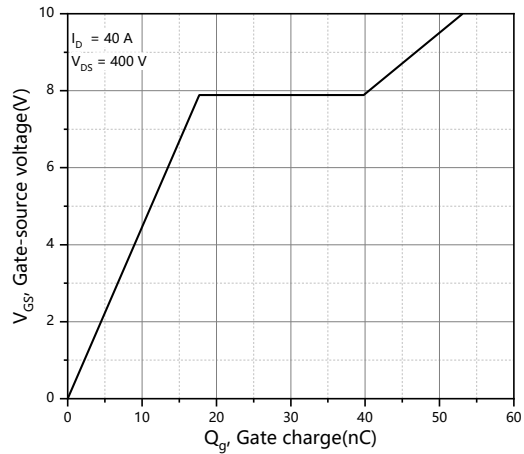
**Figure 1. Typ. output characteristics  $T_j=25^\circ\text{C}$**



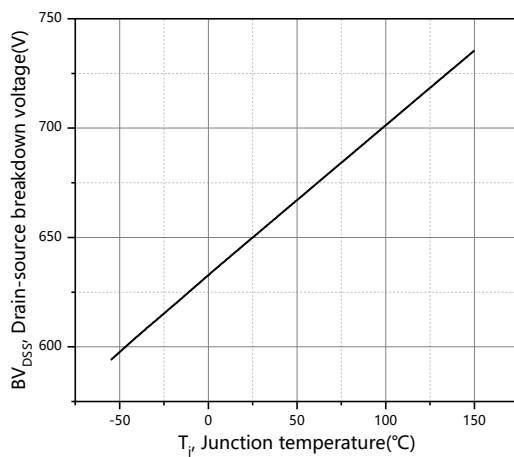
**Figure 2. Typ. transfer characteristics**



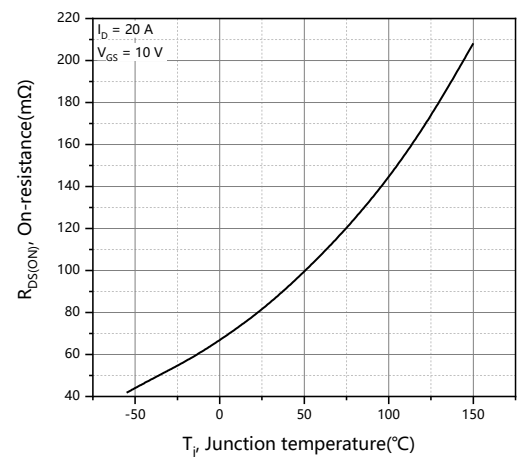
**Figure 3. Typ. capacitances**



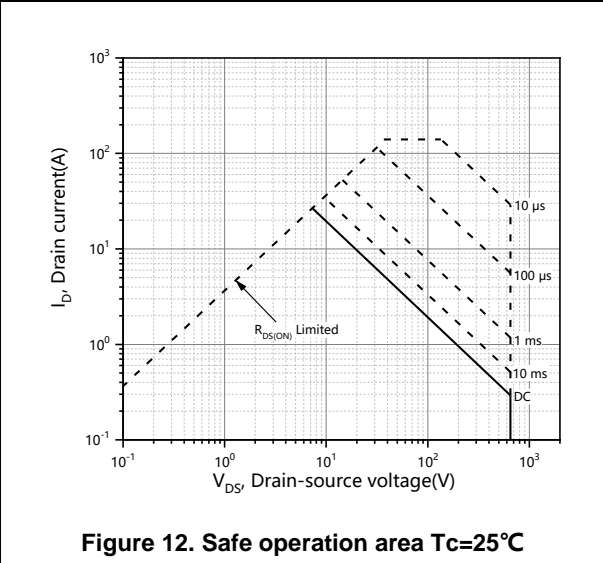
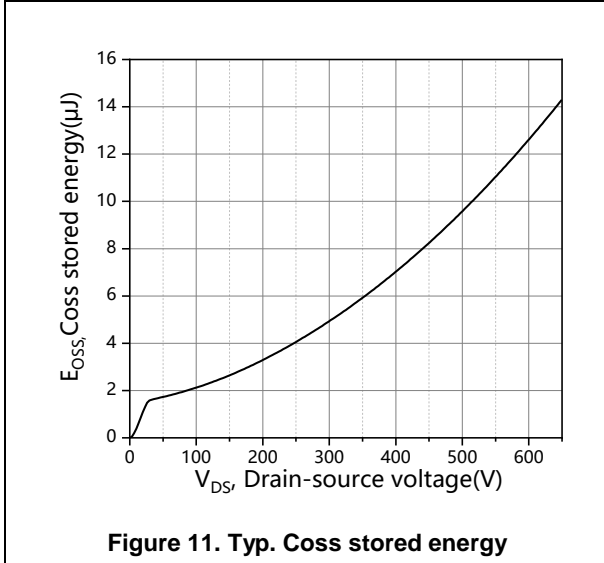
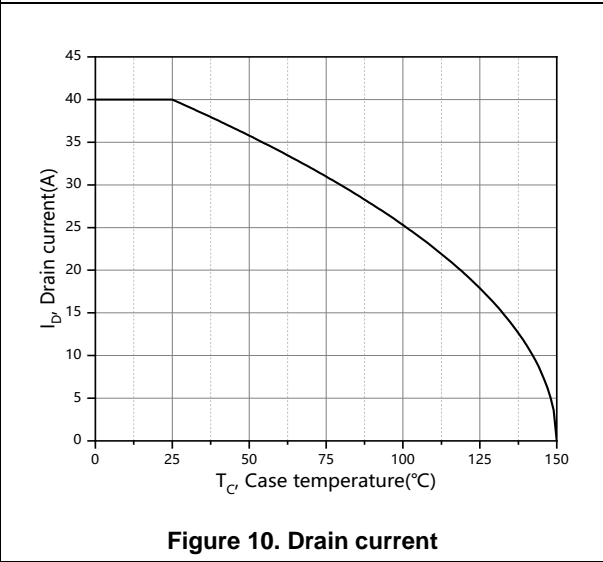
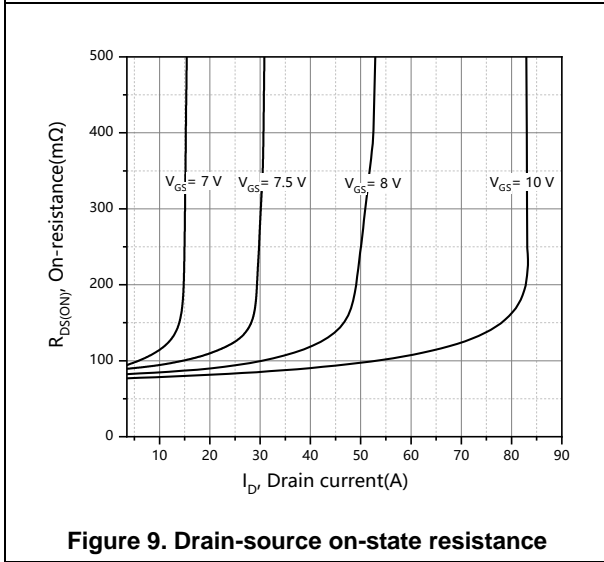
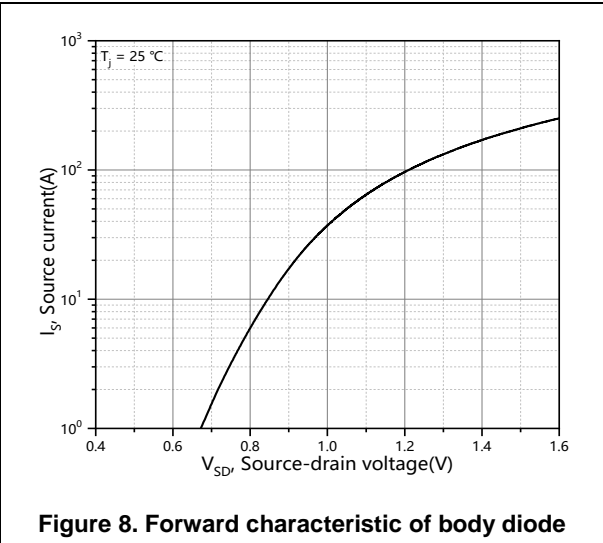
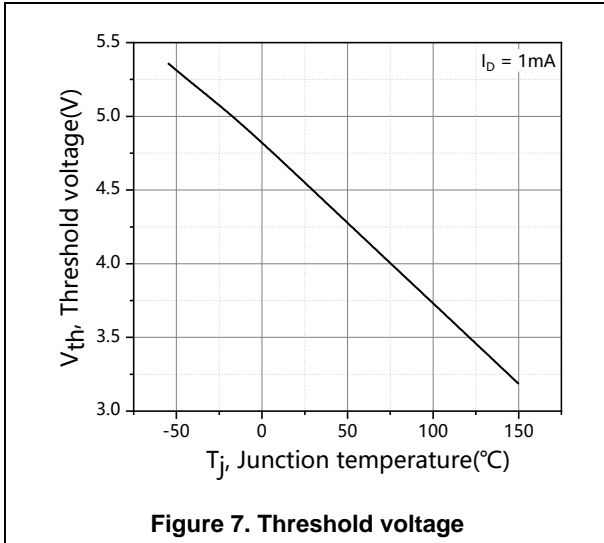
**Figure 4. Typ. gate charge**

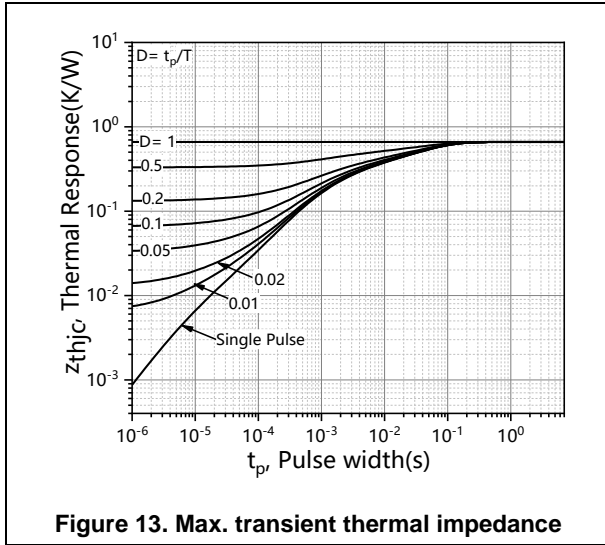


**Figure 5. Drain-source breakdown voltage**



**Figure 6. Drain-source on-state resistance**





**Test circuits and waveforms**



**Figure 1. Gate charge test circuit & waveform**



**Figure 2. Switching time test circuit & waveforms**

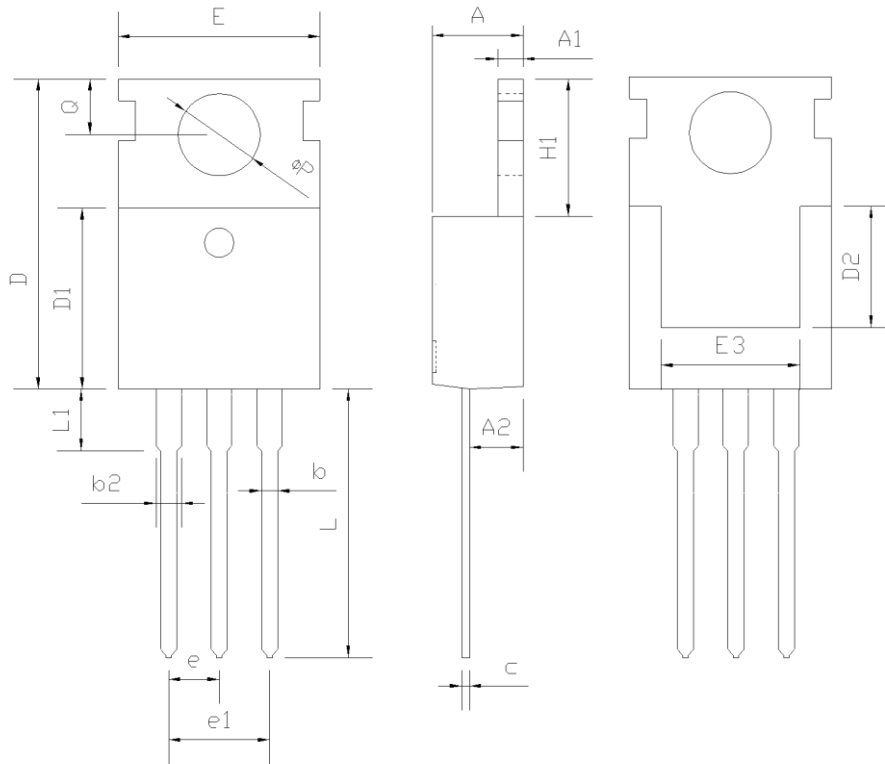


**Figure 3. Unclamped inductive switching (UIS) test circuit & waveforms**



**Figure 4. Diode reverse recovery test circuit & waveforms**

**Package Information**



Symbol	mm		
	Min	Nom	Max
A	4.37	4.57	4.77
A1	1.25	1.30	1.45
A2	2.20	2.40	2.60
b	0.70	0.80	0.95
b2	1.17	1.27	1.47
c	0.40	0.50	0.65
D	15.10	15.60	16.10
D1	8.80	9.10	9.40
D2	5.50	-	-
E	9.70	10.00	10.30
E3	7.00	-	-
e	2.54 BSC		
e1	5.08 BSC		
H1	6.25	6.50	6.85
L	12.75	13.50	13.80
L1	-	3.10	3.40
ΦP	3.40	3.60	3.80
Q	2.60	2.80	3.00

Version: TO220-P package outline dimension

## Ordering Information

Package Type	Units/ Tube	Tubes/ Inner Box	Units/ Inner Box	Inner Boxes/ Carton Box	Units/ Carton Box
TO220-P	50	20	1000	6	6000

## Product Information

Product	Package	Pb Free	RoHS	Halogen Free
OSG65R099PT3ZAF-F	TO220	yes	yes	yes

## Legal Disclaimer

The information given in this document shall in no event be regarded as a guarantee of conditions or characteristics. With respect to any examples or hints given herein, any typical values stated herein and/or any information regarding the application of the device, Oriental Semiconductor hereby disclaims any and all warranties and liabilities of any kind, including without limitation, warranties of non-infringement of intellectual property rights of any third party.

For further information on technology, delivery terms and conditions and prices, please contact the Oriental Semiconductor sales representatives ([www.orientalsemi.com](http://www.orientalsemi.com)).

© Oriental Semiconductor Co.,Ltd. All Rights Reserved 